

V1000

Inverter Series



One for all

The V1000 is a general purpose inverter drive covering the demands of a wide field of applications. Simple duties as well as requirements of complex systems need a higher level of functionality, reliability and easy handling, which are provided by the V1000.

Wherever you are -
Our support team is always close to you

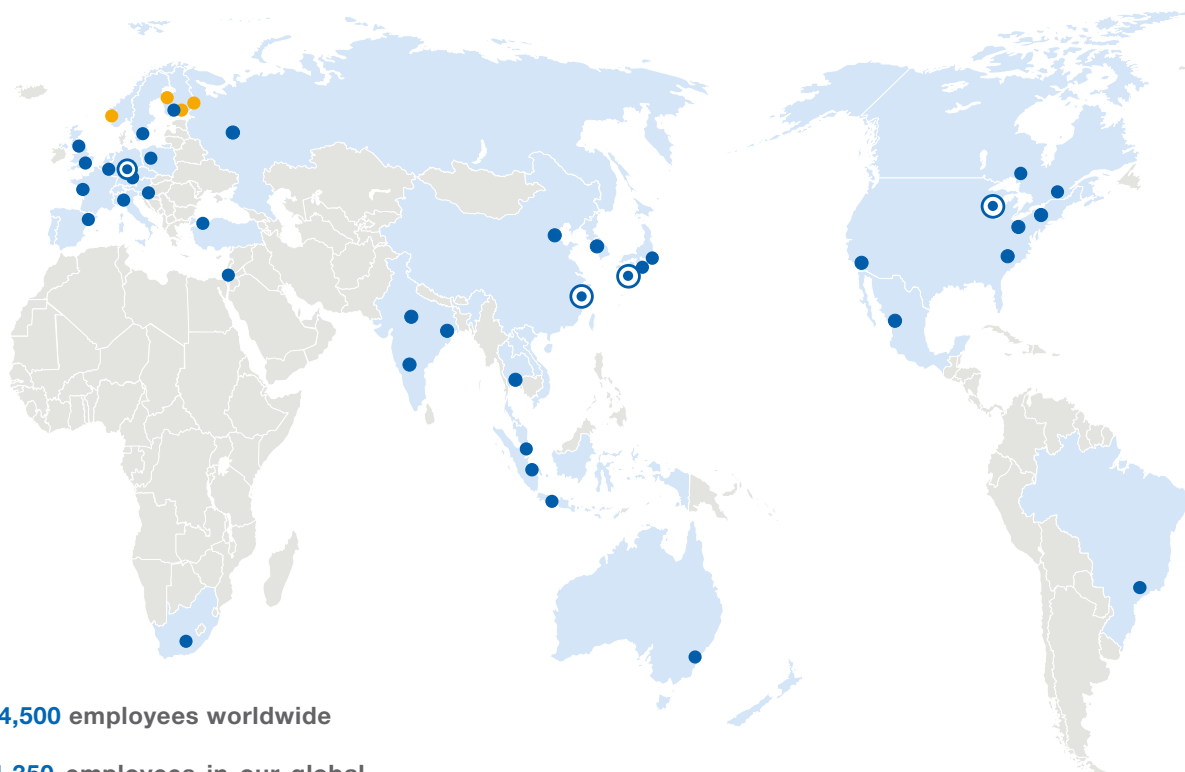

More than **14,500** employees worldwide

More than **1,350** employees in our global service network

More than **1,600** employees in europe

Easy and cost-saving

This powerful little helper sets standards in terms of user friendliness and process orientation. The development of the V1000 focuses on all aspects of application, installation, operation and maintenance.

Functional safety integrated

The V1000 comes with a built in two-channel Safe Torque Off function (STO according to IEC 61800-5-2). By that V1000 replaces motor contactors usually required for safe stop, reducing cost while increasing reliability.

Finless type

YASKAWA has as one of the first manufacturers promoted the development of finless type inverters for the European and international markets. Consequently the V1000 is available as finless version for applications with an external cooling system.

Features

- Functional Safety built in, STO according to ISO 13849-1 Cat 3, PLd and IEC 61508, SIL2
- Worldwide specification: CE, UL, cUL, RoHS
- Small Design – Big Power: 150 % overload in heavy duty service is possible, 120 % overload in normal duty mode allowing a smaller size inverter to do the job of a bigger one
- Standard AC Motor and PM motor control for highly efficient applications
- High flux braking reduces braking time to the half without using braking resistors
- Flexible base: IP20 as standard, Finless for special cooling demands, IP66 without keypad for fieldbus connection and IP66 with large key LED operator for best display readability
- High output frequency optional for spindles and other high speed applications
- V/f and open-loop current vector control
- One of the smallest inverter drives in the world
- Side-by-side mounting
- Icon-based programming
- Designed for 10 years of maintenance-free operation



Easy. Reliable. Quick.



Easy installation

YASKAWA V1000 reduces installation time and costs. Installable in tight spaces it requires a minimum of set-up time and provides you all the comfort of a modern up-to-date inverter drive.

- One of the smallest inverter drives in the world saves mounting space and cost by side-by-side mounting
- Application parameter pre-settings shorten set-up time
- Same handling and parameter structure for all YASKAWA inverters
- DriveWorksEZ visual programming tool. Simply drag and drop icons to customize your drive. Create special sequences and detection functions, then load them onto the drive.

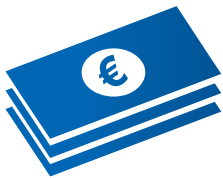

Reliable operation

The V1000 continues the tradition of YASKAWA by being the reliable link in your production chain.

- Designed for Long Performance Life (10 years 24 h per day at 80% nominal load.)
- Quick response on load and speed changes improves your machine performance
- Online Auto-Tuning to optimise for improved motor performance at low speed
- Optional external 24 VDC-supply assures communication and data flow in any power-down situation

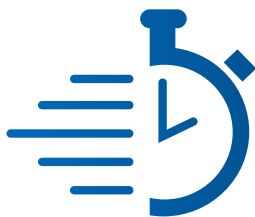

Quick maintenance

YASKAWA V1000 is an inverter drive which adapts to user demands and provides maintenance functions that ensure quick replacement and minimize down time.

- Removable terminal board with parameter memory for quick and easy maintenance
- Screwless control terminal saves setup time

For a wide range of applications

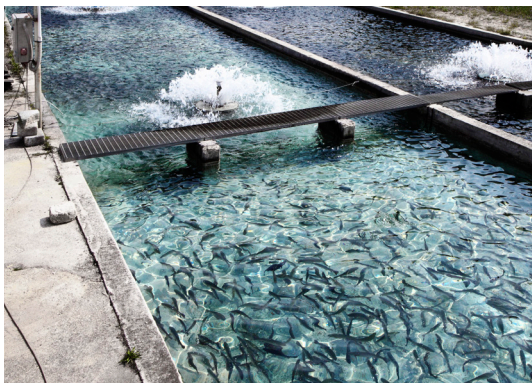
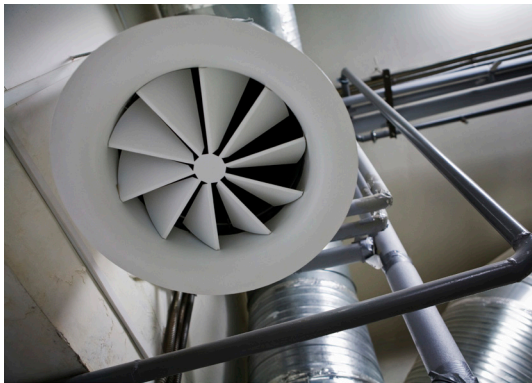

- Pumps
- Fans and blowers
- Compressors

- Conveyor belts
- Transport systems
- and many other applications

Technical information

Connection diagram

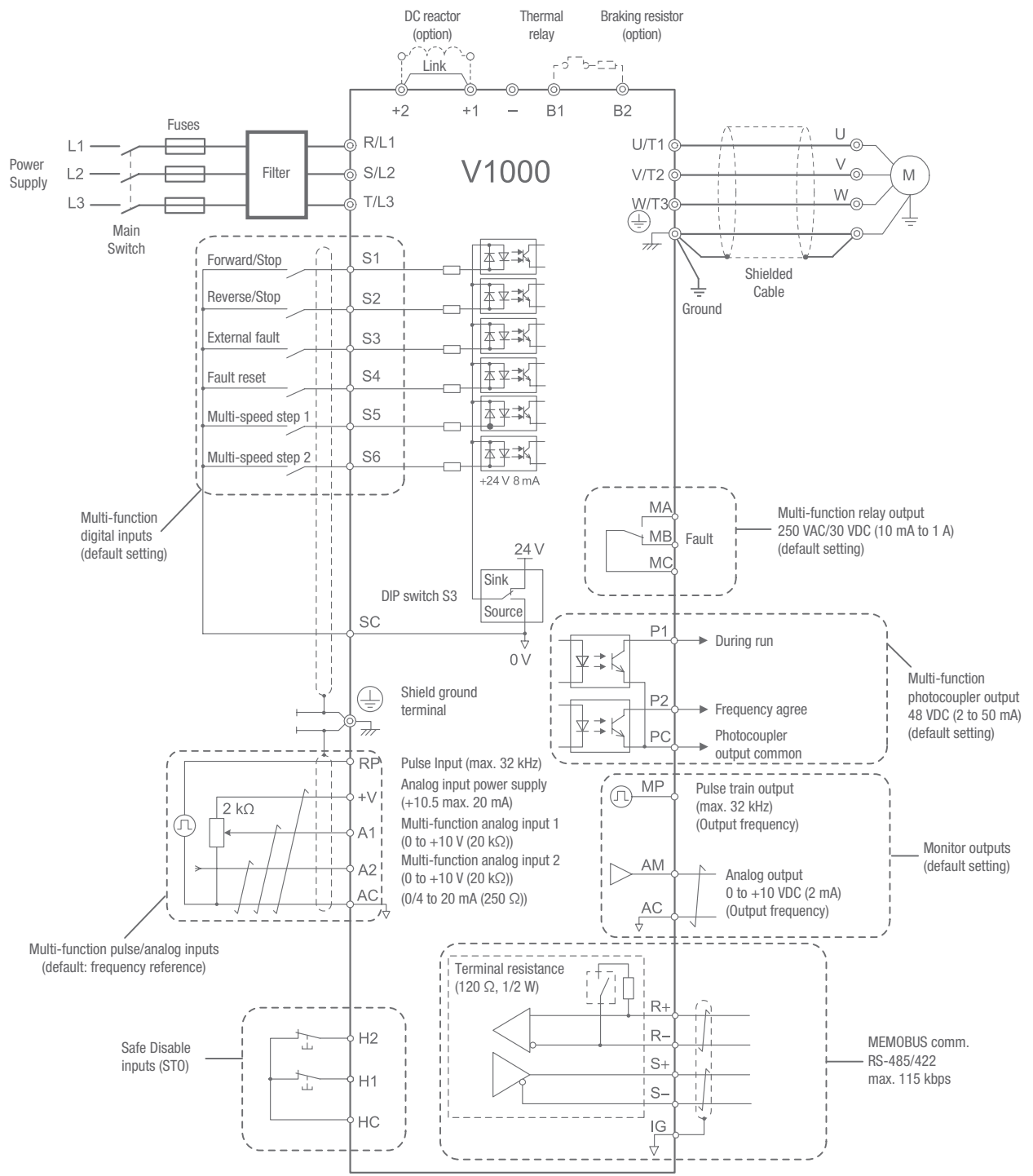

- Use twisted pair cables
- Use shielded twisted pair cables
- Indicates a main circuit terminal
- Indicates a control circuit terminal

Model code

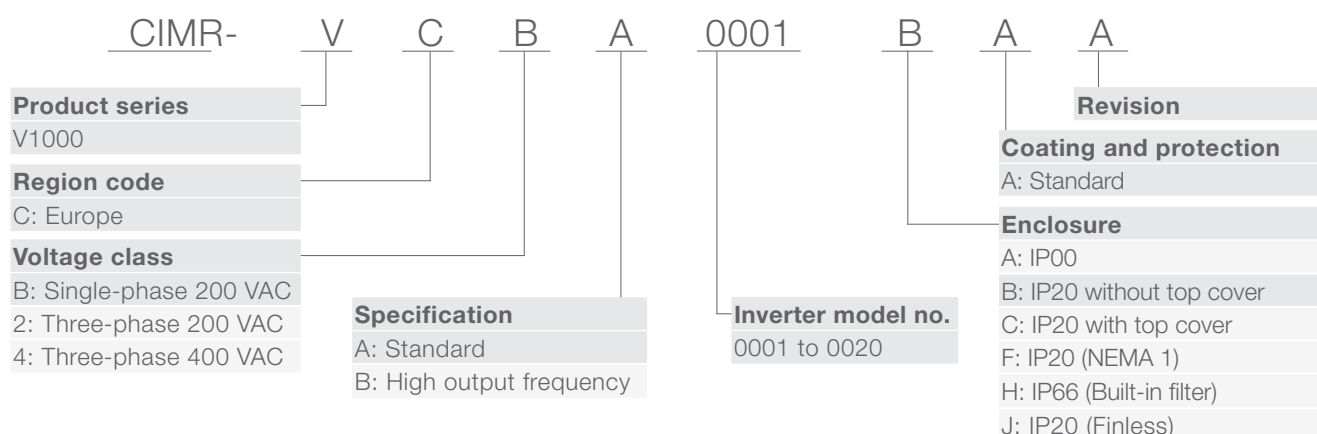

Single-phase, 200 VAC

Inverter model CIMR-VCBA**	0001	0002	0003	0006	0010	0012	0018**6
Motor output (normal duty) [kW]*2	0.18	0.37	0.75	1.1	2.2	3.0	-
Motor output (heavy duty) [kW]*2	0.1	0.18	0.55	0.75	1.5	2.2	4.0
Rated output current (normal duty) [A]*3	1.2	1.9	3.3	6.0	9.6	12.0	-
Rated output current (heavy duty) [A]	0.8*4	1.6*4	3.0*4	5.0*4	8.0*4	11.0*4	17.5*4
Overload	125% for 60 sec normal duty, 150% for 60 sec heavy duty from inverter rated output current						
Rated output power (normal duty) [kVA]	0.5	0.7	1.3	2.3	3.7	4.6	-
Rated output power (heavy duty) [kVA]	0.3	0.6	1.1	1.9	3.0	4.2	6.7
Max. output voltage	Three-phase 200 to 240V (proportional to input voltage)						
Max. output frequency	400Hz						
Rated input voltage	Single-phase 200 to 240V +10%/-15%						
Rated input frequency	50/60 Hz +/-5%						

Three-phase, 200 VAC

Inverter model CIMR-VC2A	0001	0002	0004	0006	0010	0012	0020	0030	0040	0056	0069
Motor output (normal duty) [kW]*2	0.18	0.37	0.75	1.1	2.2	3.0	5.5	7.5	11.0	15.0	18.5
Motor output (heavy duty) [kW]*2	0.1	0.2	0.4	0.75	1.5	2.2	4.0	5.5	7.5	11.0	15.0
Rated output current (normal duty) [A]*3	1.2	1.9	3.5	6.0	9.6	12.0	19.6	30.0	40.0	56.0	69.0
Rated output current (heavy duty) [A]	0.8*4	1.6*4	3.0*4	5.0*4	8.0*4	11.0*4	17.5*4	25.0*4	33.0*4	47.0*4	60.0*4
Overload	120% for 60 sec normal duty, 150% for 60 sec heavy duty from inverter rated output current										
Rated output power (normal duty) [kVA]	0.5	0.7	1.3	2.3	3.7	4.6	7.5	11.4	15.2	21.3	26.3
Rated output power (heavy duty) [kVA]	0.3	0.6	1.1	1.9	3.0	4.2	6.7	9.5	12.6	17.9	22.9
Max. output voltage	Three-phase 200 to 240V (proportional to input voltage)										
Max. output frequency	400Hz										
Rated input voltage	Single-phase 200 to 240V +10%/-15%										
Rated input frequency	50/60 Hz +/-5%										

Three-phase, 400 VAC

Inverter model CIMR-VC4A	0001	0002	0004	0005	0007	0009	0011	0018	0023	0031	0038
Motor output (normal duty) [kW]*2	0.37	0.75	1.5	2.2	3.0	4.0	5.5	7.5	11.0	15.0	18.5
Motor output (heavy duty) [kW]*2	0.18	0.37	0.75	1.5	2.2	3.0	4.0	5.5	7.5	11.0	15.0
Rated output current (normal duty) [A]*3	1.2	1.9	3.5	6.0	9.6	12.0	19.6	30.0	40.0	56.0	69.0
Rated output current (heavy duty) [A]*5	1.2	1.8	3.4	4.8	5.5	7.2	9.2	14.8	18.0	24.0	31.0
Overload	120% for 60 sec normal duty, 150% for 60 sec heavy duty from inverter rated output current										
Rated output power (normal duty) [kVA]	0.9	1.6	3.1	4.1	5.3	6.7	8.5	13.3	17.5	23.6	29.0
Rated output power (heavy duty) [kVA]	0.9	1.4	2.6	3.7	4.2	5.5	7.0	11.3	13.7	18.3	23.6
Max. output voltage	Three-phase 380 to 480V (proportional to input voltage)										
Max. output frequency	400Hz										
Rated input voltage	Three-phase 380 to 480V +10%/-15%										
Rated input frequency	50/60 Hz +/-5%										

*1 Drives with a single-phase power supply input have three-phase output. Single-phase motors cannot be used.

*2 The motor capacity (kW) refers to a YASKAWA 4-pole, 60 Hz, 200 V motor. The rated output current of the drive output amps should be equal to or greater than the motor rated current.

*3 at 2 kHz carrier frequency without derating

*4 at 10 kHz carrier frequency without derating

*5 at 8 kHz carrier frequency without derating

*6 only heavy duty available

Specifications

Control functions	
Control methods	Open loop vector control (Current vector), V/f control, PM open loop vector control (for SPM and IPM motors)
Frequency control range	0.01 to 400Hz
Frequency accuracy (Temperature fluctuation)	Digital input: within $\pm 0.01\%$ of the max. output frequency (-10°C to $+50^{\circ}\text{C}$)
	Analog input: within $\pm 0.1\%$ of the max. output frequency ($25^{\circ}\text{C} \pm 10^{\circ}\text{C}$)
Frequency setting resolution	Digital input: 0.01 Hz
	Analog input: 1/1000 of max. frequency
Starting torque	200% / 0.5Hz (assumes heavy duty rating AC motor of 3.7 kW or less using open loop vector control), 50% / 6 Hz (assumes PM open loop vector control)
Speed control range	1:100 (Open loop vector control), 1:20 to 40 (V/f control), 1:10 (PM open loop vector control)
Speed control accuracy	$\pm 0.2\%$ in open loop vector control ($25^{\circ}\text{C} \pm 10^{\circ}\text{C}$)*1
Speed response	5Hz in open loop vector ($25^{\circ}\text{C} \pm 10^{\circ}\text{C}$) (requires rotational auto-tuning)
Torque limit	Open loop vector control allows separate settings in four quadrants
Accel/Decel time	0.0 to 6,000.0s (4 selectable combinations of independent acceleration and deceleration settings)
Braking torque	<ul style="list-style-type: none"> Short-time decel torque*2: over 150% for 0.1/0.2kW motors, over 100 for 0.4/0.75kW motors, over 50% for 1.5kW motors, over 20% for 2.2kW and above motors (overexcitation braking/high-slip braking: approx. 40%) Continuous regen. torque: approx. 20% (approx. 125% with dynamic braking resistor option*3: 10% ED, 10s, internal braking transistor)
V/f characteristics	User-selected programs, V/f preset patterns possible
Main control functions	Momentary power loss ride-thru, Speed search, Overtorque detection, Torque limit, 17-step speed (max), Accel/decel time switch, S-curve accel/decel, 3-wire sequence, Auto-tuning (rotational, stationary tuning for resistance between lines), Dwell, Cooling fan on/off switch, Slip compensation, Torque compensation, Frequency jump, Upper/lower limits for frequency reference, DC injection braking at start and stop, Overexcitation braking, High slip braking, PID control (with sleep function), Energy saving control, MEMOBUS comm. (RS-485/422 max, 115.2 kbps), Fault restart, Application presets, DriveWorksEZ (customized function), Removable terminal block with parameter backup function...
Protection functions	
Motor protection	Motor overheat protection based on output current
Momentary overcurrent protection	Drive stops when output current exceeds 200% of heavy duty rating
Overload protection	Drive stops after 60s at 150% of rated output current (heavy duty rating)*4
Overvoltage protection	200V class: Stops when DC bus exceeds approx. 410 V
	400V class: Stops when DC bus exceeds approx. 820 V
Undervoltage protection	Stops when DC bus voltage falls below the following levels: 190V (3-phase 200V), 160V (single-phase 200V), 380V (3-phase 400V), 350V (3-phase 380V)
Momentary power loss ride-thru	Stops after approx. 15 ms (default). Parameter settings allow the drive to continue running if power loss lasts for up to approx. 2s*5
Heatsink overheat protection	Protection by thermistor
Braking resistance overheat protection	Overheat sensor for braking resistor (optional ERF-type, 3% ED)
Stall prevention	Separate settings allowed during acceleration, and during run. Enable/disable only during deceleration.
Ground fault protection	Protection by electronic circuit*6
Charge LED	Charge LED remains lit until DC bus has fallen below approx. 50V
Operating environment	
Area of use	Indoors
Ambient temperature	-10°C to $+50^{\circ}\text{C}$ (open chassis), -10°C to $+40^{\circ}\text{C}$ (NEMA Type 1)
Humidity	95 RH% or less (non-condensing)
Storage temperature	-20°C to $+60^{\circ}\text{C}$
Altitude	Max. 1,000 m (output derating of 1% per 100 m above 1,000 m, max. 3,000 m)
Vibration	10 to less than 20 Hz (9.8 m/s ²), max. 20 to 55 Hz (5.9 m/s ²)
Standards	CE, UL, cUL, RoHS
Protection Design	IP20 open-chassis, NEMA Type 1 enclosure, IP66

*1 Speed control accuracy may vary slightly depending on installation conditions or motor used.

*2 Momentary average deceleration torque refers to the deceleration torque from 60Hz down to 0 Hz. This may vary depending on the motor.

*3 If L3-04 is enabled when using a braking resistor or braking resistor unit, the motor may not stop within the specified deceleration time.

*4 Overload protection may be triggered at lower levels if output frequency is below 6 Hz.

*5 Varies by drive capacity. Drives smaller than 7.5 kW require a separate Momentary Power Loss Recovery Unit to continue operating during a momentary power loss of 2s.

*6 Protection may not be provided under the following conditions as the motor windings are grounded internally during run:

Low resistance to ground from the motor cable or terminal block.

Drive already has a short-circuit when the power is turned on.

Options

Name	Purpose	Model	
Input noise filter	Reduces noise from the line that enters into the drive input power system. Should be installed as close as possible to the drive.	1-phase 200 V	
		Filter	
		CIMR-VCBA0001	FS23638-10-07
		CIMR-VCBA0002	FS23638-10-07
		CIMR-VCBA0003	FS23638-10-07
		CIMR-VCBA0006	FS23638-20-07
		CIMR-VCBA0010	FS23638-20-07
		CIMR-VCBA0012	FS23638-30-07
		CIMR-VCBA0018	FS23638-40-07
		3-phase 200 V	Filter
		CIMR-VC2A0001	FS23637-8-07
		CIMR-VC2A0002	FS23637-8-07
		CIMR-VC2A0004	FS23637-8-07
		CIMR-VC2A0006	FS23637-8-07
		CIMR-VC2A0010	FS23637-14-07
		CIMR-VC2A0012	FS23637-14-07
		CIMR-VC2A0020	FS23637-24-07
		CIMR-VC2A0030	FS23637-52-07
		CIMR-VC2A0040	FS23637-52-07
		CIMR-VC2A0056	FS23637-68-07
		CIMR-VC2A0069	FS23637-80-07
		3-phase 400 V	Filter
		CIMR-VC4A0001	FS23639-5-07
		CIMR-VC4A0002	FS23639-5-07
		CIMR-VC4A0004	FS23639-5-07
		CIMR-VC4A0005	FS23639-10-07
		CIMR-VC4A0007	FS23639-10-07
CIMR-VC4A0009	FS23639-10-07		
CIMR-VC4A0011	FS23639-15-07		
CIMR-VC4A0018	FS23639-30-07		
CIMR-VC4A0023	FS23639-30-07		
CIMR-VC4A0031	FS23639-50-07		
CIMR-VC4A0038	FS23639-50-07		
Braking resistor	Used to shorten the deceleration time by dissipating regenerative energy through a resistor (3% ED).	ERF-150WJ series	
AC choke	Reducing harmonics		
Braking chopper	Shortened deceleration time results when used with a braking transistor unit.	CDBR-□□□□	
24 V power supply	Provides power supply for the control circuit and option boards. Note: Parameter settings cannot be changed when the drive is operating solely from this power supply.	PS-V10S PS-V10M	
USB copy unit (RJ-45/USB compatible plug)	Adapter for connecting the drive to the USB port of a PC (e.g. for support tool DriveWizard Plus). Can copy parameter settings to be later transferred to another drive	JVOP-181	
Support tools (DriveWizard Plus) cable	Connects the drive to a PC for use with DriveWizard.	WV103	
LCD operator	For easier operation when using the optional LCD operator. Allows for remote operation. Includes a copy function for saving drive settings.	JVOP-180	
LED operator	LED digital operator for easier operation.	JVOP-182	
Operator extension cable	Cable for connecting the LCD operator.	WV001: 1 m WV003: 3 m	
Operator mounting frame	Frame for mounting JVOP-180/182 on panel door or wall, IP65	EUOP-V11011	
Communication interface unit	MECHATROLINK-II	SI-T3/V	
	CC-Link	SI-C3/V	
	DeviceNet	SI-N3/V	
	PROFIBUS-DP	SI-P3/V	
	CANopen	SI-S3/V	
	PROFINET	SI-EP3/V	
	Modbus TCP/IP	SI-EM3/V	
	EtherCat	SI-ES3/V	
Ethernet/IP	SI-EN3/V		
Attachment for external heatsink	Mechanical kit to install the drive with the heatsink out of the cabinet.	100-034□-□□□	
DIN rail attachment kit	Mechanical kit for installation on a DIN rail.		

Dimensions

IP20/Open-chassis (without EMC filter)

Single-phase, 200 VAC

Inverter model CIMR-VC□	Figure	Dimensions [mm]			Weight [kg]
		W	H	D	
BA0001B	1	68	128	76	0.6
BA0002B		68	128	76	0.6
BA0003B		68	128	118	1.0
BA0006B	2	108	128	137.5	1.7
BA0010B		108	128	154	1.8
BA0012B		140	128	163	2.4
BA0018B		170	128	180	3.0

Three-phase, 200 VAC

Inverter model CIMR-VC□	Figure	Dimensions [mm]			Weight [kg]
		W	H	D	
2A0001B	1	68	128	76	0.6
2A0002B		68	128	76	0.6
2A0004B		68	128	108	1.0
2A0006B	2	68	128	137.5	1.7
2A0010B		108	128	154	1.8
2A0012B		108	128	163	2.4
2A0020B		140	128	180	3.0

Three-phase, 400 VAC

Inverter model CIMR-VC□	Figure	Dimensions [mm]			Weight [kg]
		W	H	D	
4A0001B	2	108	128	81	1.0
4A0002B		108	128	99	1.2
4A0004B		108	128	137.5	1.7
4A0005B		108	128	154	1.7
4A0007B		108	128	154	1.7
4A0009B		108	128	154	1.7
4A0011B		140	128	143	2.4

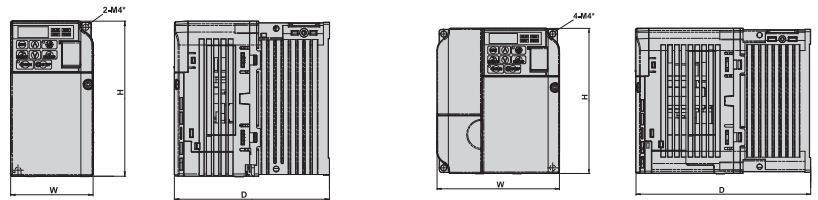

Figure 1

Figure 2

IP20/NEMA Type 1 (without EMC filter)

Single-phase, 200 VAC

Inverter model CIMR-VC□	Figure	Dimensions [mm]			Weight [kg]
		W	H	D	
BA0001F	3	68	149.5	76	0.8
BA0002F		68	149.5	76	0.8
BA0003F		68	149.5	118	1.2
BA0006F	4	108	149.5	137.5	1.9
BA0010F		108	149.5	154	2.0
BA0012F		140	153	163	2.6
BA0018F		170	171	180	3.3

Three-phase, 200 VAC

Inverter model CIMR-VC□	Figure	Dimensions [mm]			Weight [kg]
		W	H	D	
2A0001F	3	68	149.5	76	0.8
2A0002F		68	149.5	76	0.8
2A0004F		68	149.5	108	1.1
2A0006F	4	68	149.5	128	1.3
2A0010F		108	149.5	129	1.9
2A0012F		108	149.5	137.5	1.9
2A0020F		140	153	143	2.6
2A0030F		140	254	140	3.8
2A0040F	5	140	254	140	3.8
2A0056F		180	290	163	5.5
2A0069F		220	350	187	9.2

Three-phase, 400 VAC

Inverter model CIMR-VC□	Figure	Dimensions [mm]			Weight [kg]
		W	H	D	
4A0001F	4	108	149.5	81	1.2
4A0002F		108	149.5	99	1.4
4A0004F		108	149.5	137.5	1.9
4A0005F		108	149.5	154	1.9
4A0007F		108	149.5	154	1.9
4A0009F		108	149.5	154	1.9
4A0011F		140	153	143	2.6
4A0018F		140	254	140	3.8
4A0023F	5	140	254	140	3.8
4A0031F		180	290	143	5.2
4A0038F		180	290	163	5.5

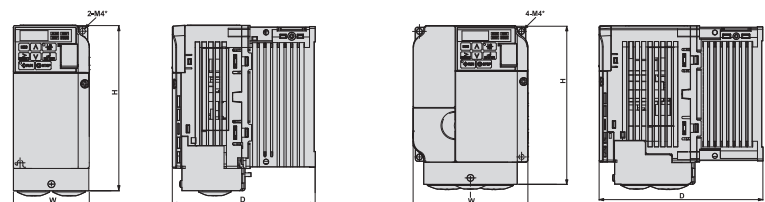

Figure 3

Figure 4

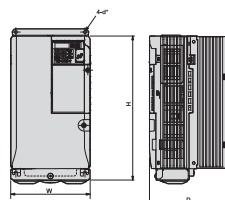

Figure 5

Finless

Single-phase, 200 VAC

Inverter model CIMR-VC□	Figure	Dimensions [mm]			Weight [kg]
		W	H	D	
BA0001J	6	68	128	71	0.6
BA0002J		68	128	71	0.6
BA0003J		68	128	81	0.8
BA0006J	7	108	128	79.5	1.1
BA0010J		108	128	91	1.1
BA0012J	8	140	128	98	1.4

Three-phase, 200 VAC

Inverter model CIMR-VC□	Figure	Dimensions [mm]			Weight [kg]
		W	H	D	
2A0001J	6	68	128	71	0.6
2A0002J		68	128	71	0.6
2A0004J		68	128 <td 71	0.7	
2A0006J	7	68	128	71	0.7
2A0008J		108	128	71	1.0
2A0010J	8	108	128	71	1.0
2A0012J		108	128	79.5	1.0
2A0018J		140	128	78	1.3
2A0020J	9	140	128	78	1.3
2A0030J		140	260	145	3.2
2A0040J	9	140	260	145	3.2
2A0056J		180	300	147	4.6
2A0069J		220	350	152	7.0

Three-phase, 400 VAC

Inverter model CIMR-VC□	Figure	Dimensions [mm]			Weight [kg]
		W	H	D	
4A0001J	7	108	128	71	0.9
4A0002J		108	128	71	0.9
4A0004J		108	128	79.5	1.0
4A0005J		108	128	96	1.0
4A0007J		108	128	96	1.1
4A0009J	8	108	128	96	1.1
4A0011J		140	128	78	1.3
4A0018J	9	140	260	145	3.1
4A0023J		140	260	145	3.2
4A0031J		180	300	147	4.3
4A0038J		180	300	147	4.6

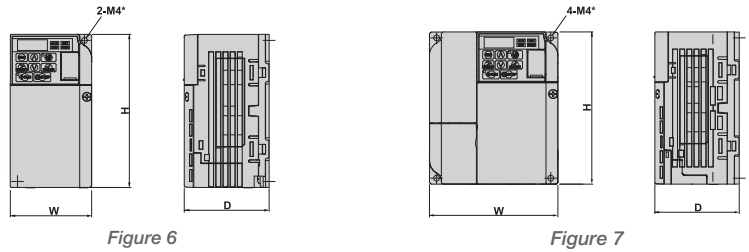

Figure 6

Figure 7

IP66

Single-phase, 200 VAC

Inverter model CIMR-VC□	Figure	Dimensions [mm]			Weight [kg]
		W	H	D	
BA0001H□□-0080/0081	10	262	340	173.5	4.9
BA0002H□□-0080/0081		262	340	173.5	4.9
BA0003H□□-0080/0081		262	340	173.5	5.1
BA0006H□□-0080/0081		262	340	173.5	5.7
BA0010H□□-0080/0081		262	340	173.5	5.8
BA0012H□□-0080/0081		262	340	173.5	6.1

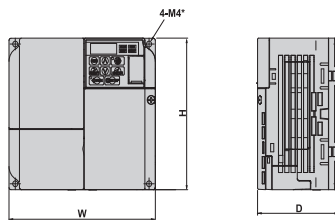

Figure 8

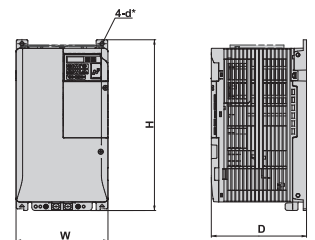

Figure 9

Three-phase, 400 VAC

Inverter model CIMR-VC□	Figure	Dimensions [mm]			Weight [kg]
		W	H	D	
4A0001H□□-0080/0081	10	262	340	173.5	5.2
4A0002H□□-0080/0081		262	340	173.5	5.2
4A0004H□□-0080/0081		262	340	173.5	5.3
4A0005H□□-0080/0081		262	340	173.5	5.3
4A0007H□□-0080/0081		262	340	173.5	5.7
4A0009H□□-0080/0081		262	340	173.5	5.7
4A0011H□□-0080/0081	11	262	340	173.5	6.0
4A0018H□□-0080/0081		345	500.5	273.5	19.8
4A0023H□□-0080/0081		345	500.5	273.5	19.9
4A0031H□□-0080/0081		345	500.5	273.5	21.0
4A0038H□□-0080/0081		345	500.5	273.5	21.3

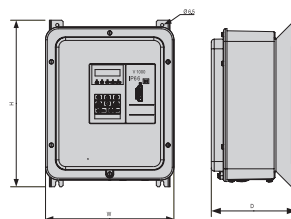

Figure 10

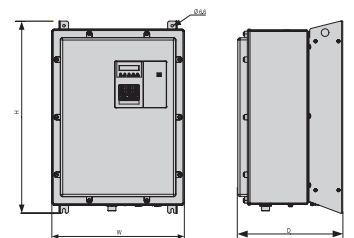

Figure 11

YASKAWA Europe GmbH
Drives & Motion Division
Hauptstr. 185
65760 Eschborn
Germany

+49 6196 569-500
support@yaskawa.eu.com
www.yaskawa.eu.com

Specifications are subject to change without notice
for ongoing product modifications and improvements.
© YASKAWA Europe GmbH. All rights reserved.

03/2017
YEU_INV_V1000_EN_V7

YASKAWA