



for a greener tomorrow



**MITSUBISHI  
ELECTRIC**

*Changes for the Better*

FACTORY AUTOMATION

# INVERTER FREQROL-CS80



# FREQROL-**CS80**

COMPACT & SMART



# GLOBAL IMPACT OF MITSUBISHI ELECTRIC



Through Mitsubishi Electric's vision, "Changes for the Better" are possible for a brighter future.

## *Changes for the Better*

We bring together the best minds to create the best technologies. At Mitsubishi Electric, we understand that technology is the driving force of change in our lives. By bringing greater comfort to daily life, maximizing the efficiency of businesses and keeping things running across society, we integrate technology and innovation to bring changes for the better.

Mitsubishi Electric is involved in many areas including the following

### **Energy and Electric Systems**

A wide range of power and electrical products from generators to large-scale displays.

### **Electronic Devices**

A wide portfolio of cutting-edge semiconductor devices for systems and products.

### **Home Appliance**

Dependable consumer products like air conditioners and home entertainment systems.

### **Information and Communication Systems**

Commercial and consumer-centric equipment, products and systems.

### **Industrial Automation Systems**

Maximizing productivity and efficiency with cutting-edge automation technology.

<b>Features</b>	<b>4</b>	<b>1</b>
<b>Example Connection</b>	<b>10</b>	<b>2</b>
<b>Standard Specifications</b>	<b>11</b>	<b>3</b>
<b>Outline Dimensions</b>	<b>13</b>	<b>4</b>
<b>Terminal Connection Diagram, Terminal Specifications</b>	<b>14</b>	<b>5</b>
<b>Explanation of the Control Panel and Parameter Unit</b>	<b>16</b>	<b>6</b>
<b>FR Configurator2</b>	<b>20</b>	<b>7</b>
<b>Parameter List</b>	<b>21</b>	<b>8</b>
<b>Protective Functions</b>	<b>26</b>	<b>9</b>
<b>Option and Peripheral Devices</b>	<b>28</b>	<b>10</b>
<b>Precautions for Operation/Selection, Precautions for Peripheral Device Selection</b>	<b>32</b>	<b>11</b>
<b>Warranty</b>	<b>35</b>	<b>12</b>

# Various Functions in a Small Body Compact and Smart Inverter

**Feature 1** World's smallest class compact body

Compact size achieved by the low heat generation design



In-house comparison  
Volume reduction to **57%**

For the FR-CS84-012-60  
<Conventional model>  
128 mm (H) x 108 mm (W) x 129.5 mm (D)  
<CS80>  
128 mm (H) x 68 mm (W) x 117.9 mm (D)

Actual size of the FR-CS84-012-60

## Space saving by the side-by-side installation

Side-by-side installation is possible\*. Three FR-CS84-012-60 inverters can be installed in space for two conventional models to save space.

A DIN rail installation attachment (FR-UDA□□) option can be used. (excluding inverters FR-CS84-120 to 295)

\* Keep the surrounding air temperature of the inverter at 40 °C maximum.

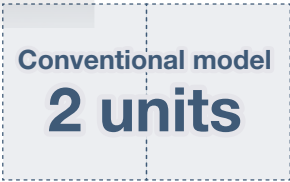

**Feature 2 High performance**

**Compact yet high performance**

**General-purpose magnetic flux vector control**

General-purpose magnetic flux vector control and auto tuning functions are available. These functions ensure the applications that require high starting torque, such as washing machines, agitators, and transfer machines including conveyors, hoists, and elevators.

- High torque of 150% / 1 Hz is realized (when the slip compensation function is valid).
- Auto tuning
- With our "non-rotation" auto tuning function the motor constant (R1) can be automatically calculated.

**Brake unit connection Option**

Brake unit can be connected using terminal P/+ and terminal N/-. It is useful for applications require regenerative braking torque during deceleration, such as transfer machines and food machines.

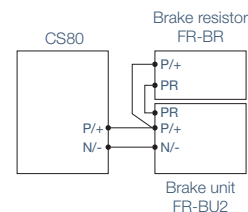

When using the inverter with the brake unit, use the FR-CS84-050-60 or higher capacity inverter.

**Optimum excitation control**

The excitation current is constantly adjusted to its optimum value to drive the motor most efficiently. With a small load torque, a substantial energy saving can be achieved.

**Feature 3 Easy to use**

**Easy-to-read operation panel**

**Operation panel FR-LU08 Option**

An optional LCD operation panel (FR-LU08) is also available.



**Enclosure surface operation panel FR-PA07 Option**

The operation panel enables inverter operation and monitoring of frequency setting from the enclosure surface.



**Parameter unit FR-PU07 Option**

The parameter unit features helpful settings such as direct input with ten-key pad, operating status display, and help function. Eight languages are supported. Parameter settings for up to three units can be saved.



The operation panel cannot be removed from the inverter. The separate parameter unit connection cable (FR-CB20II) is required. To connect the FR-LU08, the operation panel connection connector (FR-ADP) is also required.

**Shorter startup time with easy setup**

**Inverter setup software FR Configurator2 Option**

The software is easy to use and has unity as Mitsubishi Electric FA products with MELSOFT common design and good operability. Free trial version, which contains start-up functions, is available. It can be downloaded at Mitsubishi Electric FA Global Website.

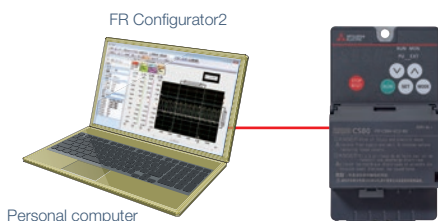

**Supporting high-speed communication**

**RS-485 communication**

Using a controller, the inverter can be controlled and monitored via network. The standard model with an RS-485 interface (Mitsubishi inverter protocol, MODBUS RTU protocol) enables communication with the speed of up to 115.2 kbps.

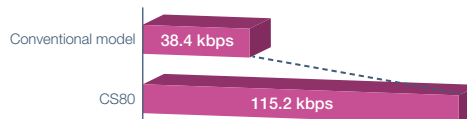

**Easy-to-follow display improves the operability**

**Easy connection with GOT**

When the automatic connection is enabled, the inverter can communicate with the GOT2000 series simply by connecting the GOT.



**Feature 4** Easy maintenance

**Reduced wiring check time**

The wiring can be checked only by lifting the control terminal cover, which makes maintenance work easier.



**Easy wiring to the control circuit**

**Spring clamp terminals (control circuit terminals)**

Spring clamp terminals\*1 provide high reliability and easy wiring.

\*1: The main circuit terminals are screw terminals.

- Easy wiring  
Wiring is completed only by inserting the dedicated blade terminal of each cable. Without using the blade terminal, the loose wires can also be connected using a flathead screwdriver.

Easy wiring. Just insert.

- High reliability  
Internal terminal contacts are spring-type. Therefore, wires can be protected against loosening or contact faults due to vibrations during operation on a bogie or during transport.
- Maintenance-free  
No additional screw tightening is required.

Assures the tensile strength of the DIN standards.

(Example: transport of the inverters)

**Protected in hazardous environments**

The circuit board coating conforms to IEC 60721-3-3 3C2/3S2 for improved environmental resistance.



Front

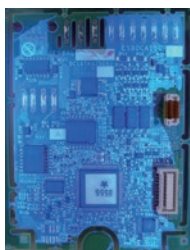

Back



# Lineup

FR-CS84 - 080 - 60

Symbol	Voltage class
2	200 V class
4	400 V class

Symbol	Power supply
None	Three-phase
S	Single-phase

Symbol	Description
012 to 295	Inverter rated current (A)

Symbol	Circuit board coating (conforming to IEC 60721-3-3 3C2/3S2)
60	With

Power supply	Inverter model	012	022	036	050	080	120	160	230	295
Three-phase 400 V	FR-CS84-[-]60	●	●	●	●	●	●	●	●	●

Power supply	Inverter model	025	042	070	100
Single-phase 200 V	FR-CS82S-[-]60	●	●	●	●

●: Released model



## Environment consciousness in global standard

**Compliant with the EU RoHS Directive  
(Restriction of the Use of Certain  
Hazardous Substances in Electrical  
and Electronic Equipment)**

Being RoHS compliant, the inverter is friendly to people and the environment.

[RoHS Directive]

RoHS Directive requires member nations to guarantee that new electrical and electronic equipment sold in the market after July 1, 2006 do not contain lead, cadmium, mercury, hexavalent chromium, polybrominated biphenyl (PBB) and polybrominated diphenyl ether (PBDE) flame retardants. The <G> mark indicating RoHS Directive compliance is on the package.

**EMC Directive  
compliant noise filter**

Compliance to the EMC Directive (EN standard) is easier.

Noise filter option which is compliant with the EMC Directive (EN61800-3 2nd Environment Category C3) is available.

**Compatibility  
with various standards**

The inverters are compatible with UL, cUL, EC Directives (CE marking).



# Variety of Functions to Support Various Applications

## Spinning

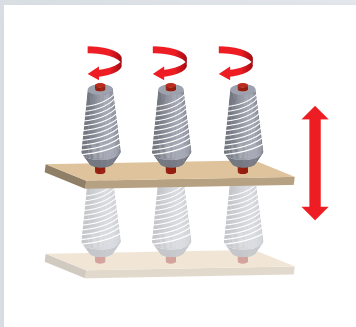

### Traverse function

The traverse function, used for the traverse axis of spinning machine, prevents uneven winding or collapsing.

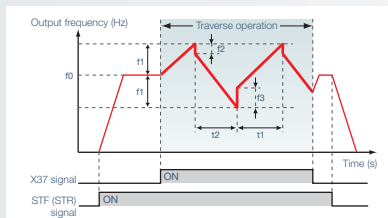

f0: set frequency  
f1: amplitude amount from the set frequency  
f2: compensation amount at transition from acceleration to deceleration  
f3: compensation amount at transition from deceleration to acceleration  
t1: time for acceleration during traverse operation  
t2: time for deceleration during traverse operation

### Power failure time deceleration-to-stop function

The motor decelerates to a stop without coasting when power failure or undervoltage occurs. Slack in the thread can be controlled even if there is a power failure.

### Continuous operation function at instantaneous power failure

Even in the event of an instantaneous power failure, motor operation continues without coasting and production is maintained.

## Conveyor

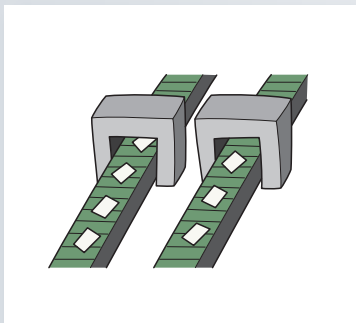

### Increased excitation deceleration

The deceleration time can be reduced without using a brake resistor. The tact time can be reduced for a transfer line or the like.

### Communication operation (RS-485 communication)

Conveyor belts can be controlled individually by using multiple inverters. Automatic operation is possible by collectively managing multiple inverters.

### S-pattern acceleration/deceleration

An S-pattern is maintained from the present frequency to the target frequency; therefore it is possible to reduce shock during acceleration/deceleration and prevent load shifts.

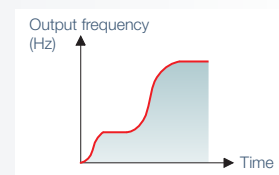

## Fan and pump



### Optimum excitation control

This control enables the motor efficiency to its optimum. More energy saving is possible in applications with variable load torque characteristic such as fan and pump.

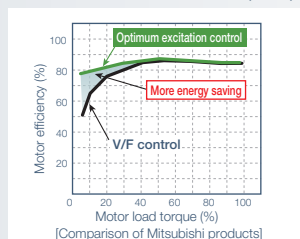

### PID control

Flow rate and air volume is controlled by an inverter. It is possible to regulate flow rate and air volume so that they stay at a pre-set level.

### Adjustable 3 points V/F

The optimal V/F pattern matching the torque characteristics of the facility can be set.



**Fountain**

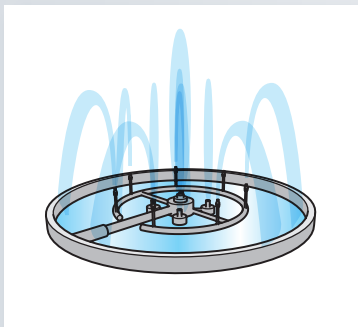

**General-purpose magnetic flux vector control  
Brake unit connection**

A variety of fountain displays are possible by connecting a brake unit which allows high starting torque and improved braking efficiency during deceleration under General-purpose magnetic flux vector control.

**Continuous operation function at instantaneous power failure**

Even in the event of an instantaneous power failure, motor operation continues without coasting and the fountain's operations are undisturbed.

**Multi-speed function (Up to 15-speed switching operation)**

Operation speeds can be pre-set via parameters. Motor speed to meet the height requirements of the fountain can be set and easily changed.

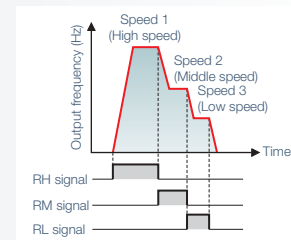

**Wood processing machine**

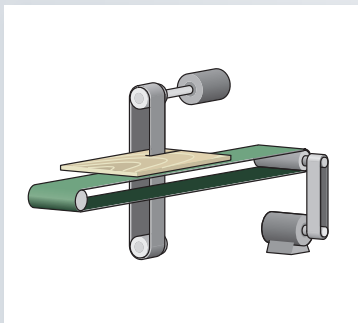

**Continuous operation function at instantaneous power failure**

Even in the event of an instantaneous power failure, motor operation continues without coasting and production is maintained.

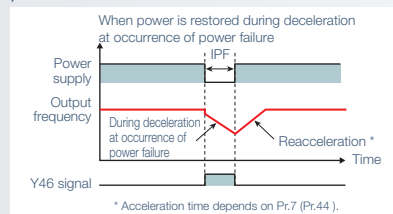

**Power failure time deceleration-to-stop function**

The motor decelerates to a stop without coasting when power failure or undervoltage occurs. This function is useful for stopping the motor at power failure to prevent danger.

**Multi-speed function (Up to 15-speed switching operation)**

Operation speeds can be pre-set via parameters. Operation speed suitable for the ingredients being used can be set and easily changed.

**Food machinery**

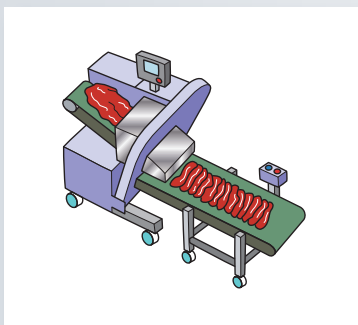

**General-purpose magnetic flux vector control**

Depending on the type of ingredients, with the right amount of low speed torque it is possible to regulate a suitable speed for food production.

**Fast-response current limit**

Operation continues and the overcurrent alarm is not activated even if there is a sudden change in load during the cutting of food.

**Power failure time deceleration-to-stop function**

The motor decelerates to a stop without coasting when power failure or undervoltage occurs. This function is useful for stopping the motor at power failure to prevent danger.

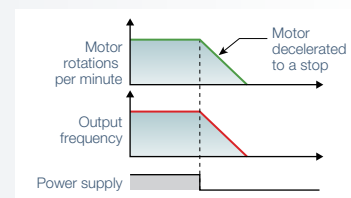

# Example Connection

2

Example Connection



### AC power supply

Must be within the permissible power supply specifications of the inverter.



### Molded case circuit breaker (MCCB), earth leakage circuit breaker (ELB), or fuse

Must be selected carefully since an inrush current flows in the inverter at power ON.



### Magnetic contactor (MC)

Install this to ensure safety. Do not use this to start and stop the inverter. Doing so will shorten the life of the inverter.



### AC reactor (FR-HAL)

Install this to suppress harmonics and to improve the power factor. An AC reactor (FR-HAL) (option) is required when installing the inverter near a large power supply system (500 kVA or more). Under such condition, the inverter may be damaged if you do not use a reactor. Select a reactor according to the applied motor capacity.



### Noise filter (ferrite core) (FR-BSF01, FR-BLF)

Install this to reduce the electromagnetic noise generated from the inverter. The noise filter is effective in the range from about 0.5 to 5 MHz. A wire should be wound four turns at maximum.



### Parameter unit (FR-PU07)

### Enclosure surface operation panel (FR-PA07)

By connecting the connection cable (FR-CB2) to the PU connector, operation can be performed from FR-PU07, FR-PA07, FR-LU08.

### Liquid crystal display operation panel (FR-LU08)



### Personal computer (FR Configurator2)

RS-232C - RS-485 converter is required when connecting to PC with RS-232C interface.

### RS-485 - RS-232C Converter

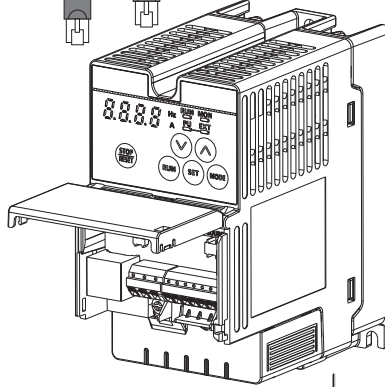

### Inverter (FR-CS80)

The life of the inverter is influenced by the surrounding air temperature. The surrounding air temperature should be as low as possible within the permissible range. This must be noted especially when the inverter is installed in an enclosure. Incorrect wiring may lead to damage of the inverter. The control signal lines must be kept fully away from the main circuit lines to protect them from noise.

R/L1 S/L2 T/L3

Earth (Ground)

### Radio noise filter (FR-BIF)

Install this to reduce the radio noise.

P/+ N/-

U V W

### Noise filter (ferrite core) (FR-BSF01, FR-BLF)

Install this to reduce the electromagnetic noise generated from the inverter. The noise filter is effective in the range from about 0.5 to 5 MHz. A wire should be wound four turns at maximum.



### High power factor converter (FR-HC2)

Suppresses the power supply harmonics significantly.



### Power regeneration common converter (FR-CV)

Provides a large braking capability.



### Resistor unit (FR-BR) Discharging resistor (GZG, GRZG)

Allows the inverter to provide the optimal regenerative braking capability.

### Brake unit (FR-BU2)

P/+ PR  
P/+ PR  
PR



### Induction motor

Connect a squirrel-cage induction motor.

### Earth (Ground)

To prevent electric shock, always earth (ground) the motor and inverter. For reduction of induction noise from the power line of the inverter, it is recommended to wire the earth (ground) cable by returning it to the earth (ground) terminal of the inverter.

Earth (Ground)

■ : Install these options as required.

# Standard Specifications

## ● Rating

### ◆ Three-phase 400 V class.

Model FR-CS84-□		012	022	036	050	080	120	160	230	295	
Applicable motor capacity (kW) *1		0.4	0.75	1.5	2.2	3.7	5.5	7.5	11	15	
Output	Rated capacity (kVA) *2	0.9	1.7	2.7	3.8	6.1	9.1	12.2	17.5	22.5	
	Rated current (A)*3	1.2 (1.0)	2.2 (1.9)	3.6 (3.1)	5.0 (4.3)	8.0 (6.8)	12.0 (10.2)	16.0 (13.6)	23.0 (19.6)	29.5 (25.1)	
	Overload current rating *4	150% 60 s, 200% 0.5 s (inverse-time characteristics).									
	Rated voltage *5	Three-phase 380 to 480 V.									
Power supply	Rated input AC voltage/frequency	Three-phase 380 to 480 V, 50/60 Hz.									
	Permissible AC voltage fluctuation	325 to 528 V, 50/60 Hz.									
	Permissible frequency fluctuation	±5%									
	Power supply capacity (kVA) *6	1.5	2.5	4.5	5.5	9.5	12.0	17.0	20.0	28.0	
Protective structure (IEC 60529)		Open type (IP20).									
Cooling system		Natural.					Forced air.				
Approx. mass (kg)		0.6	0.6	0.9	0.9	1.4	1.9	1.9	3.5	3.5	

\*1 The applicable motor capacity indicated is the maximum capacity applicable for use of the Mitsubishi Electric 4-pole standard motor.

\*2 The rated output capacity at an output voltage of 440 V.

\*3 When using the inverter in a surrounding air temperature of 50°C, the rated current is decreased to the value shown in the parentheses.

\*4 The percentage of the overload current rating is the ratio of the overload current to the inverter's rated output current. For prolonged use, allow time for the inverter and motor to return to or fall below the temperatures under 100% load.

\*5 The maximum output voltage does not exceed the power supply voltage. The maximum output voltage can be changed within the setting range. However, the maximum point of the voltage waveform at the inverter output side is the power supply voltage multiplied by about  $\sqrt{2}$ .

\*6 The power supply capacity is the value at the rated output current. The input power impedances (including those of the input reactor and cables) affect the value.

### ◆ Single-phase 200 V class.

Model FR-CS82S-□		025	042	070	100
Applicable motor capacity (kW) *1		0.4	0.75	1.5	2.2
Output	Rated capacity (kVA) *2	1.0	1.7	2.8	4.0
	Rated current (A)*3	2.5 (2.1)	4.2 (3.6)	7.0 (6.0)	10.0 (8.5)
	Overload current rating *4	150% 60 s, 200% 0.5 s (inverse-time characteristics).			
	Rated voltage *5	Three-phase 200 to 240 V			
Power supply	Rated input AC voltage/frequency	Single-phase 200 to 240 V, 50/60 Hz			
	Permissible AC voltage fluctuation	170 to 264 V, 50/60 Hz			
	Permissible frequency fluctuation	±5%			
	Power supply capacity (kVA) *6	1.5	2.3	4.0	5.2
Protective structure (IEC 60529)		Open type (IP20).			
Cooling system		Natural.			Forced air.
Approx. mass (kg)		0.6	0.6	1.4	1.4

\*1 The applicable motor capacity indicated is the maximum capacity applicable for use of the Mitsubishi Electric 4-pole standard motor.

\*2 The rated output capacity at an output voltage of 230 V.

\*3 When using the inverter in a surrounding air temperature of 50°C, the rated current is decreased to the value shown in the parentheses.

\*4 The percentage of the overload current rating is the ratio of the overload current to the inverter's rated output current. For repeated duty, allow time for the inverter and motor to return to or below the temperatures under 100% load. If the automatic restart after instantaneous power failure function (Pr. 57) or power failure stop function (Pr. 261) is set and power supply voltage is low while load becomes bigger, the bus voltage decreases to power failure detection level and load of 100% or more may not be available.

\*5 The maximum output voltage does not exceed the power supply voltage. The maximum output voltage can be changed within the setting range. However, the maximum point of the voltage waveform at the inverter output side is the power supply voltage multiplied by about  $\sqrt{2}$ .

\*6 The power supply capacity is the value at the rated output current. The input power impedances (including those of the input reactor and cables) affect the value.

## ● Common specifications

Control	Control method		Soft-PWM control, high carrier frequency PWM control (selectable among V/F control, General-purpose magnetic flux vector control, Optimum excitation control).
	Output frequency range		0.2 to 400 Hz.
	Frequency setting and resolution	Analog input	0.06/60 Hz at 0 to 10 V / 10 bits (terminals 2 and 4). 0.12/60 Hz at 0 to 5 V / 9 bits (terminals 2 and 4). 0.06/60 Hz at 0 to 20 mA / 10 bits (terminal 4).
		Digital input	0.01 Hz.
	Frequency accuracy	Analog input	Within $\pm 1\%$ of the maximum output frequency at 25°C ( $\pm 10^\circ\text{C}$ ).
		Digital input	0.01% or less of the set output frequency.
	Voltage/frequency characteristics		Base frequency can be set from 0 to 400 Hz. Constant-torque or adjustable 3 points V/F can be selected.
	Starting torque		150% or more at 1 Hz, with General-purpose magnetic flux vector control and slip compensation.
	Torque boost		Manual torque boost.
	Acceleration/deceleration time setting		0.1 to 3600 s (acceleration and deceleration can be set individually), linear or S-pattern acceleration/deceleration modes are available.
	DC injection brake		Operation frequency (0 to 120 Hz), operation time (0 to 10 s), operation voltage (0 to 30%) variable.
	Stall prevention operation level		Operation current: 0 to 200% variable, with selectable availability of the function.
Operation	Frequency setting signal	Analog input (2)	Terminal 2: 0 to 10 V / 0 to 5 V. Terminal 4: 0 to 10 V / 0 to 5 V / 4 to 20 mA.
		Digital input	Input from the operation panel or parameter unit, with selectable frequency setting increments
	Start signal		Forward and reverse rotation or start signal automatic self-holding input (3-wire input) can be selected.
	Input signal (5)		Using <b>Pr.178 to Pr.182 (input terminal function selection)</b> , the signal can be selected from the following: Multi-speed selection, Remote setting, Second acceleration/deceleration function selection, Terminal 4 input selection, JOG operation selection, PID control valid terminal, External thermal relay input, Output stop, Start self-holding selection, Forward rotation command, Reverse rotation command, Inverter reset, Traverse function selection.
	Operational function		Maximum frequency, minimum frequency, frequency jump operation, external thermal relay input selection, automatic restart after instantaneous power failure operation, forward/reverse rotation prevention, remote setting, second acceleration/deceleration function, multi-speed operation, regeneration avoidance, slip compensation, operation mode selection, offline auto tuning, PID control, computer link operation (RS-485 communication), Optimum excitation control, power failure stop, MODBUS RTU, increased magnetic excitation deceleration.
Output signal relay output (1)		Using <b>Pr.195 output terminal function selection</b> , the signal can be selected from the following: Inverter running, Up to frequency, Overload warning, Output frequency detection, Electronic thermal O/L relay pre-alarm, Inverter operation ready, Output current detection, PID lower limit, PID upper limit, PID forward/reverse rotation output, Heatsink overheat pre-alarm, During deceleration at occurrence of power failure, During PID control activated, PID output interruption, During retry, Alarm output, Fault output, Fault output 3.	
Indication	Operation panel	Status monitoring	Selectable from the following: output frequency, output current (steady state), output voltage, frequency setting, cumulative energization time, actual operation time, converter output voltage, electronic thermal relay function load factor, motor load factor, PID set point, PID measured value, PID deviation, inverter I/O terminal monitor, output power, cumulative energy, motor thermal load factor, inverter thermal load factor.
		Fault record	Fault record is displayed when a protective function is activated. Past 8 fault records are stored. (output voltage, output current, frequency, and cumulative energization time right before the protective function is activated.)
	Parameter unit (FR-PU07)	Interactive guidance	Help function for operation guide*1.
Protective function	Fault		Overcurrent during acceleration, Overcurrent during constant speed, Overcurrent during deceleration, Overvoltage during acceleration, Overvoltage during constant speed, Overvoltage during deceleration, Inverter overload trip (electronic thermal relay function), Motor overload trip (electronic thermal relay function), Heatsink overheat, Input phase loss*3, Output side earth (ground) fault overcurrent at start, Output short circuit, Output phase loss, External thermal relay operation*2, Parameter error, PU disconnection*2, Retry count excess*2, CPU fault, Inrush current limit circuit fault, 4 mA input fault*2, Stall prevention stop, Output current detection value exceeded*2, Inverter output fault*5, Undervoltage.
	Alarm, Warning, Error message		Overcurrent stall prevention, Overvoltage stall prevention, PU stop, Parameter write error, Electronic thermal O/L relay pre-alarm, Undervoltage, Inrush current limit resistor heating, Operation panel lock, Password locked, Inverter reset.
Environment	Surrounding air temperature		-10 to +40°C (non-freezing)*4, 40 to 50°C (non-freezing) at the rated current reduced by 15%
	Surrounding air humidity		95% RH or less (non-condensing) for models with circuit board coating.
	Storage temperature*6		-20 to +65°C
	Ambience		Indoors (free from corrosive gas, flammable gas, oil mist, dust or dirt).
	Altitude/vibration		2500 m or less (For the installation at an altitude above 1000 m, consider a 3% reduction in the rated current per 500 m increase in altitude.)/ 5.9 m/s <sup>2</sup> or less at 10 to 55 Hz (directions of X, Y, Z axes)

\*1 Available for the option parameter unit (FR-PU07) only.

\*2 This protective function is not available in the initial status.

\*3 Available for the three-phase power input models.

\*4 When using the inverters at the surrounding air temperature of 40°C or less, the inverters can be installed closely attached (0 cm clearance).

\*5 Available for the FR-CS84-160 or lower or the FR-CS82S.

\*6 Applicable to conditions for a short time, for example, in transit.

# Outline Dimensions

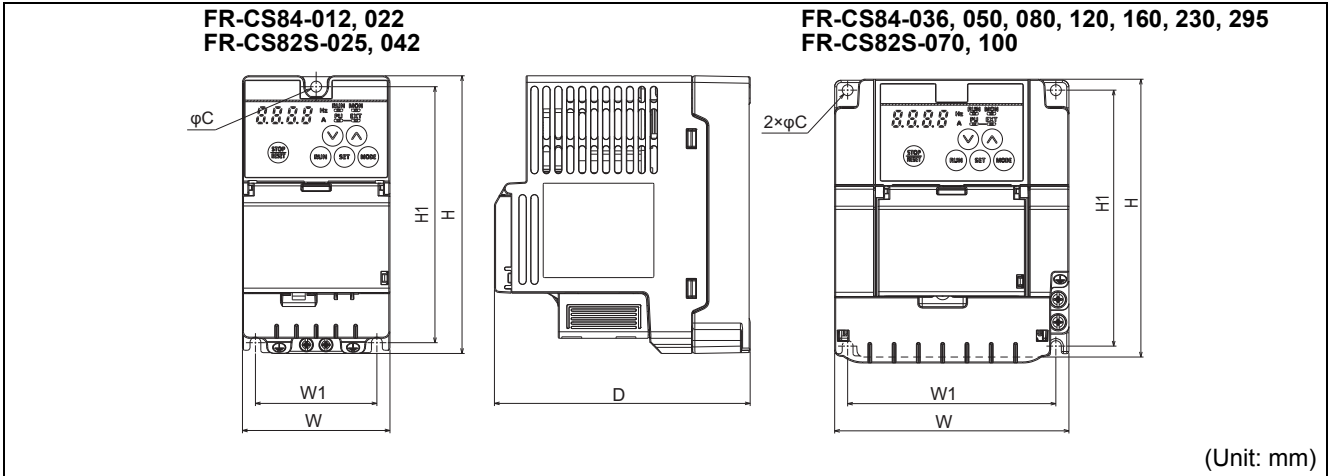

## ◆ Three-phase 400 V class.

Inverter model	W	W1	H	H1	D	C
FR-CS84-012	68	56	128	118	118	5
FR-CS84-022					130	
FR-CS84-036	108	96			160	
FR-CS84-050			197.5	185.5	150	138
FR-CS84-080	180	164	260	244	165	6
FR-CS84-120						
FR-CS84-160						
FR-CS84-230	180	164	260	244	165	6
FR-CS84-295						

## ◆ Single-phase 200 V class.

Inverter model	W	W1	H	H1	D	C
FR-CS82S-025	68	56	128	118	118	5
FR-CS82S-042					130	
FR-CS82S-070	108	96			160	
FR-CS82S-100						

# Terminal connection diagram

Source logic

- ⊙ Main circuit terminal
- Control circuit terminal

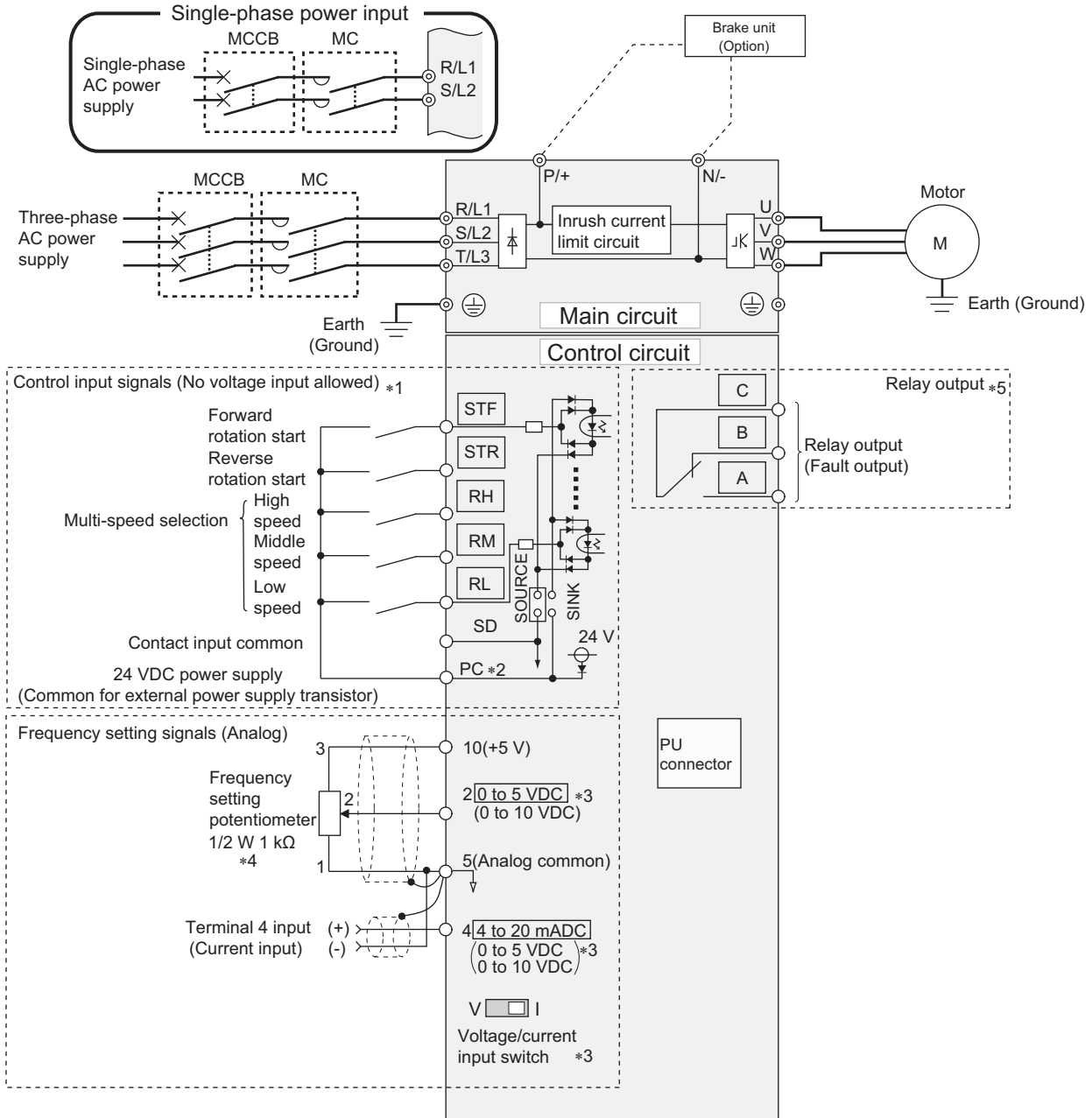

- \*1 The signal assigned to each of these terminals can be changed to the reset signal, etc. using the input terminal assignment function (Pr.178 to Pr.182).
- \*2 To use terminals PC and SD for a 24 VDC power supply, check the wiring for an incorrect short of these terminals.
- \*3 Terminal input specifications can be changed by analog input specification switchover (Pr.73, Pr.267). To input voltage via terminal 4, set the voltage/current input switch to "V" position. To input current (4 to 20 mA), set it to "I" position (initial setting).
- \*4 It is recommended to use a 2 W 1 kΩ potentiometer when the frequency setting is frequently changed.
- \*5 The function of these terminals can be changed with the output terminal assignment (Pr.195).

5

Terminal connection diagram

# Terminal Specifications

Terminal names and terminal functions are those of the factory set.

Type	Terminal symbol	Terminal name	Description		
Main circuit	R/L1, S/L2, T/L3	AC power input	Connect these terminals to the commercial power supply.		
	U, V, W	Inverter output	Connect a three-phase squirrel-cage motor to these terminals.		
	P/+, N/-	Brake unit connection	Connect the brake unit (FR-BU2), power regeneration common converter (FR-CV), or high power factor converter (FR-HC2) to these terminals.		
		Earth (ground)	For earthing (grounding) the inverter chassis. Be sure to earth (ground) the inverter.		
Control circuit/input signal	STF*1	Forward rotation start	Turn ON the STF signal to start forward rotation and turn it OFF to stop.	When the STF and STR signals are turned ON simultaneously, the stop command is given.	
		STR*1	Reverse rotation start		Turn ON the STR signal to start reverse rotation and turn it OFF to stop.
		RH, RM, RL*1	Multi-speed selection	Multi-speed can be selected according to the combination of RH, RM and RL signals.	
	SD	Contact input common (sink)	Common terminal for the contact input terminal (sink logic).		
		External transistor common (source)	Connect this terminal to the power supply common terminal of a transistor output (open collector output) device, such as a programmable controller, in the source logic to avoid malfunction by undesirable current.		
		24 VDC power supply common	Common terminal for the 24 VDC power supply (terminal PC). Isolated from terminal 5.		
	PC	External transistor common (sink)	Connect this terminal to the power supply common terminal of a transistor output (open collector output) device, such as a programmable controller, in the sink logic to avoid malfunction by undesirable current.		
		Contact input common (source)	Common terminal for contact input terminal (source logic).		
		24 VDC power supply	Can be used as a 24 VDC 30 mA power supply.		
	Frequency setting	10	Frequency setting power supply	Used as the power supply for an external device such as a frequency setting potentiometer or digital panel meter.	5 VDC ( $\pm 0.2$ VDC), permissible load current: 10 mA
		2	Frequency setting (voltage)	Inputting 0 to 5 VDC (or 0 to 10 VDC) provides the maximum output frequency at 5 V (or 10 V) and makes input and output proportional. Use <b>Pr.73</b> to switch between input 0 to 5 VDC (initial setting) and 0 to 10 VDC.	Input resistance: 10 k $\Omega$ ( $\pm 1$ k $\Omega$ ), Maximum permissible voltage: 20 VDC.
		4	Frequency setting (current)	Inputting 4 to 20 mADC (or 0 to 5 V, 0 to 10 V) provides the maximum output frequency at 20 mA and makes input and output proportional. This input signal is valid only when the AU signal is ON (terminal 2 input is invalid). Use <b>Pr.267</b> to switch among input 4 to 20 mA (initial setting), 0 to 5 VDC, and 0 to 10 VDC. Set the voltage/current input switch in the "V" position to select voltage input (0 to 5 V / 0 to 10 V).	For voltage input, input resistance: 10 k $\Omega$ ( $\pm 1$ k $\Omega$ ), maximum permissible voltage: 20 VDC. For current input, input resistance: 249 $\Omega$ ( $\pm 5$ $\Omega$ ), permissible maximum current: 30 mA.
		5	Frequency setting common	Common terminal for the frequency setting signal input (via terminal 2 or 4). Do not earth (ground).	
Relay	A, B, C*1	Relay output (fault output)	1 changeover contact output that indicates that an inverter's protective function has been activated and the outputs are stopped. Fault: discontinuity across B and C (continuity across A and C), Normal: continuity across B and C (discontinuity across A and C)	Contact capacity: 30 VAC 0.3 A (power factor = 0.4), 30 VDC 0.3 A	
Communication	RS-485	PU connector	The PU connector supports the RS-485 communication. Conforming standard: EIA-485 (RS-485) Transmission format: Multidrop link Communication speed: 4800 to 115200 bps Wiring length: 500 m		

\*1 Indicates that terminal functions can be selected using **Pr.178** to **Pr.182** and **Pr.195** (I/O terminal function selection).

# Explanation of the Operation Panel

## ● Components of the operation panel

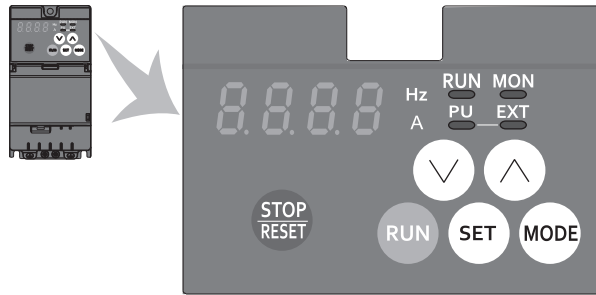

No.	Appearance	Name	Description
(a)		Inverter operation mode LED indicator	PU: ON when the inverter runs in the PU operation mode. EXT: ON when the inverter runs in the External operation mode. (ON when the inverter in the initial setting is powered ON.) PU and EXT: ON when the inverter runs in the External/PU combined operation mode. PU and EXT (blinking): Blinks when the inverter runs in the Network operation mode.
(b)		Operation panel mode LED indicator	ON when the operation panel is in the monitor mode. Quickly blinks twice intermittently while the protective function is activated.
(c)		Inverter operating status indicator	ON or blinks during inverter operation. ON: During forward rotation operation Blinks slowly: During reverse rotation operation Blinks quickly: Operation is disabled although the start command is given.
(d)		Unit indicator	Hz: ON when the actual frequency is monitored. (Blinks when the set frequency is monitored.) A: ON when the current is monitored.
(e)		Monitor display (4-digit LED)	Shows a numeric value (readout) of a monitor item such as the frequency or a parameter number. (The monitor items can be changed according to the settings of Pr.774 to Pr.776.)
(f)		STOP/RESET key	Stops the operation commands. Used to reset the inverter when the protective function is activated.
(g)		UP/DOWN key	Used to change the setting of frequency or parameter, etc. The following operations are also enabled: <ul style="list-style-type: none"> <li>• Displaying the present setting during calibration</li> <li>• Displaying a fault record number in the fault history</li> </ul>
(h)		MODE key	Switches the monitor screen (item) in the monitor mode. Every key on the operation panel becomes inoperable (locks) by holding this key for 2 seconds. The key lock function is disabled when Pr.161 = "0 (initial value)". Holding this key for one second displays the initial screen. (During normal inverter operation it will appear as the first screen in the monitor mode; during abnormal operation it will appear as the first screen in the fault history mode. Reverts to the previous screen if pressed during frequency setting when the easy setting function is enabled.  Initial setting in monitor mode <div style="display: flex; align-items: center; gap: 10px;"> <div style="border: 1px solid black; padding: 2px;">Output frequency</div> <div>→</div> <div style="border: 1px solid black; padding: 2px;">Output current</div> <div>→</div> <div style="border: 1px solid black; padding: 2px;">Output voltage</div> <div>→</div> <div style="border: 1px solid black; padding: 2px;">Faults history</div> <div>→</div> <div style="border: 1px solid black; padding: 2px;">Operation mode switchover</div> </div> <div style="display: flex; align-items: center; gap: 10px;"> <div style="border: 1px solid black; padding: 2px;">Output frequency</div> <div>↑</div> </div>
(i)		SET key	Confirms each selection. Pressing this key in a mode other than the parameter setting mode will display the first screen in the parameter settings.
(j)		RUN key	Used to give the start command to the inverter. The rotation direction depends on the Pr.40 setting.



● Basic operation

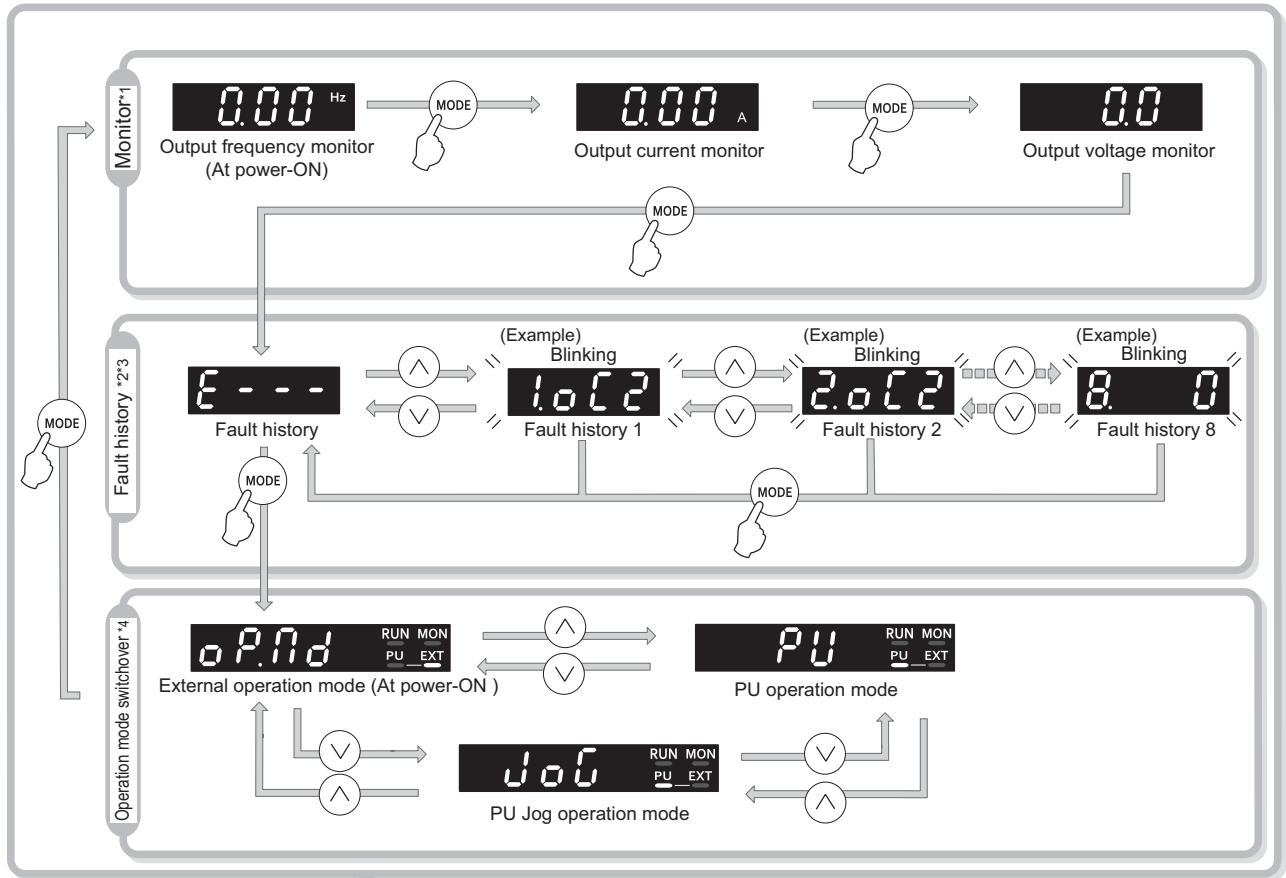

Pressing the MODE key while in the "P. 0" screen returns to the monitor screen.

Pressing the SET key while in any of the screens above will change to the parameter setting screen.

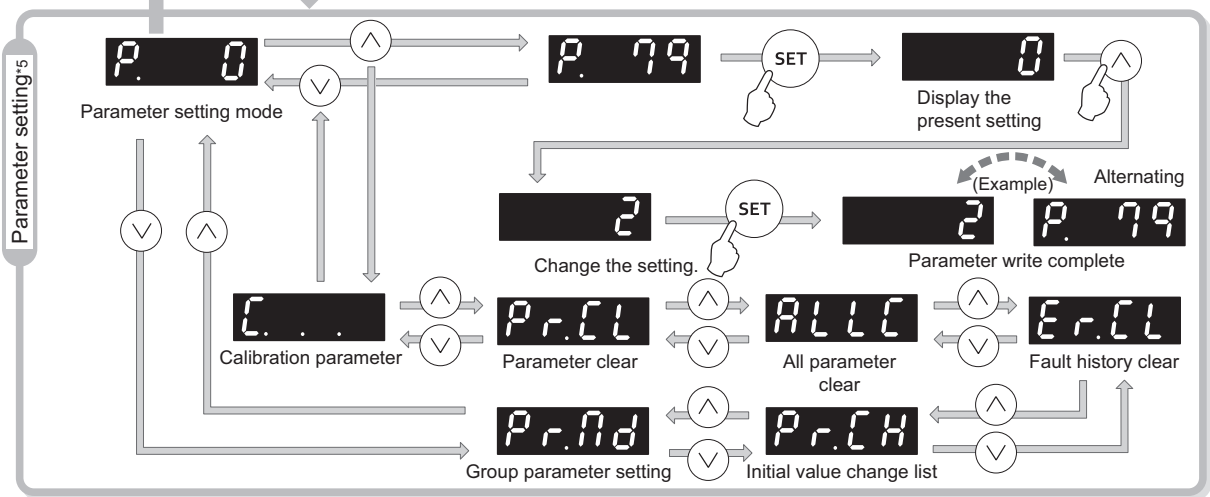

- \*1 The monitor item can be changed.
- \*2 For fault history details, refer to the Instruction Manual of the FR-CS80 inverters.
- \*3 When there is no fault history, "0" is displayed.
- \*4 For the details of operation modes, refer to the Instruction Manual.
- \*5 "P. 0" will appear if the MODE key is pressed during parameter setting.

# FR-LU08 LCD Operation Panel

- The FR-LU08 is an optional operation panel adopting an LCD panel capable of displaying text and menus.
- Installation of the FR-LU08 on the enclosure surface is possible when using an optional parameter unit connection cable (FR-CB2[ ]).  
(To connect the (FR-LU08), an optional operation panel connection connector (FR-ADP) is required.)
- Parameter settings for up to three inverters can be saved.

## ● Appearance and parts name

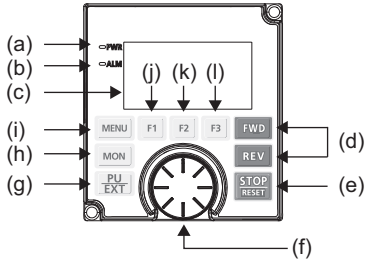

Symbol	Name	Description
a	Power lamp	ON when the power is turned ON.
b	Alarm lamp	ON when an inverter fault occurs.
c	Monitor	Shows a numeric value (readout) of a monitor item such as the frequency or a parameter number. (The monitor item can be changed according to the settings of Pr.774 to Pr.776.)
d	FWD key, REV key	FWD key: Starts the forward rotation operation. REV key: Starts the reverse rotation operation.
e	STOP/RESET key	Stops operation commands. Used to reset the inverter when the protective function is activated.
f	Setting dial	Turn the setting dial to change the setting of frequency or parameter, etc. Press the setting dial to display a fault history number in the fault history mode.
g	PU/EXT key	Switches between the PU operation mode, the PUJOG operation mode, and the External operation mode.
h	MON key	Shows the first priority monitor screen.
i	MENU key	Displays the quick menu. When this key is pressed while the quick menu is displayed, the function menu is displayed.
j	Software key (F1)	Select a guidance displayed on the monitor.
k	Software key (F2)	
l	Software key (F3)	

## ● Switching the main monitor data

Pressing **F1 (PREV)** or **F3 (NEXT)** displays 6 types of monitor screens in order.

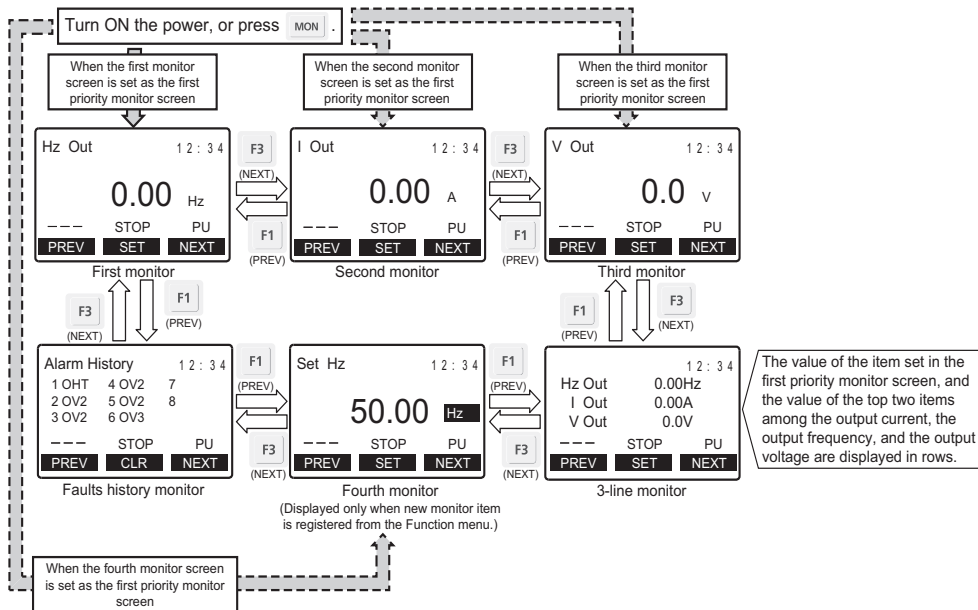

# Parameter unit (FR-PU07)

- The parameter unit is an optional unit which has a ten-key direct input keypad, operating status display, and help function to make setting the inverter more convenient. The parameter unit connection cable FR-CB20[] is required to connect to the inverter.
- Eight languages can be displayed.
- Parameter setting values of maximum of three inverters can be stored.

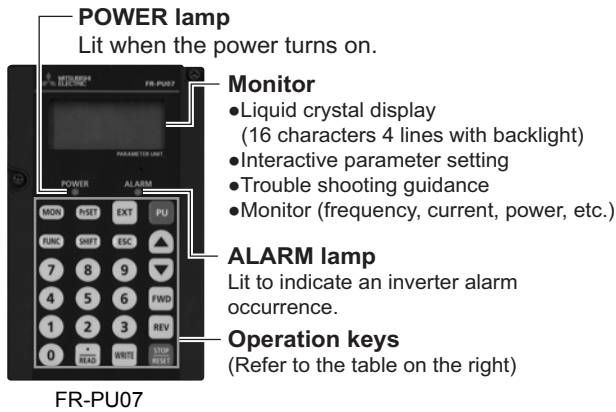

Key	Description
<b>PrSET</b>	Use for parameter setting Press to choose the parameter setting mode.
<b>MON</b>	First priority monitor is displayed. In the initial setting, the output frequency is displayed.
<b>ESC</b>	Operation cancel key
<b>FUNC</b>	Used to display the function menu. A variety of functions can be used on the function menu.
<b>SHIFT</b>	Used to shift to the next item in the setting or monitoring mode.
<b>0 to 9</b>	Used to enter a frequency, parameter number or set value.
<b>EXT</b>	Inverter operates in the External operation mode.
<b>PU</b>	Used to select the PU operation mode to display the frequency setting screen.
<b>▲ ▼</b>	Used to keep on increasing or decreasing the running frequency. Hold down to vary the frequency. Press either of these keys on the parameter setting mode screen to change the parameter setting value sequentially. On the selecting screen, these keys are used to move the cursor.
<b>FWD</b>	Forward rotation command key.
<b>REV</b>	Reverse rotation command key.
<b>STOP RESET</b>	Stop command key. Used to reset the inverter when an alarm occurs.
<b>WRITE</b>	Used to write a set value in the setting mode. Used as a clear key in the all parameter clear or alarm history clear mode.
<b>• READ</b>	Used as a decimal point when entering numerical value. The monitor screen selected by the cursor appears.

## ◆ Main functions

Function	Description
Monitor	6 types of monitors appear by simply pressing <b>SHIFT</b> .
Frequency setting	For PU operation mode and External/PU combined operation mode ( <b>Pr.79</b> = "3"), frequency setting is available. Settings is performed by the direct setting, which sets frequency directly by <b>0</b> to <b>9</b> , and the step setting, which sets frequency continuously by <b>▲ ▼</b> .
Parameter Setting	Reading parameter and changing setting values are easily done. To change the setting value of an parameter, specify the parameter number, or select a parameter from the functional parameter list.
Batch copy	FR-PU07 reads parameter settings of an inverter, and stores three different parameter settings. FR-PU07 can also copy the stored parameter setting to another inverter of the same series, or verify its stored parameter setting against the parameter setting stored in an inverter.
Operation	Switching between External operation mode [EXT] and PU operation mode [PU] is easy. Start/stop is enabled during PU operation mode and External/PU operation mode ( <b>Pr.79</b> = "3").

# INVERTER SETUP SOFTWARE (FR Configurator2)

Inverter setup software is optional software in which anything from setup to maintenance can be easily carried out via a personal computer.

## ◆ Intuitive user interface

Connected inverters are displayed in tree view format.

Windows for each function can be accessed by changing the tab for maximum efficiency.

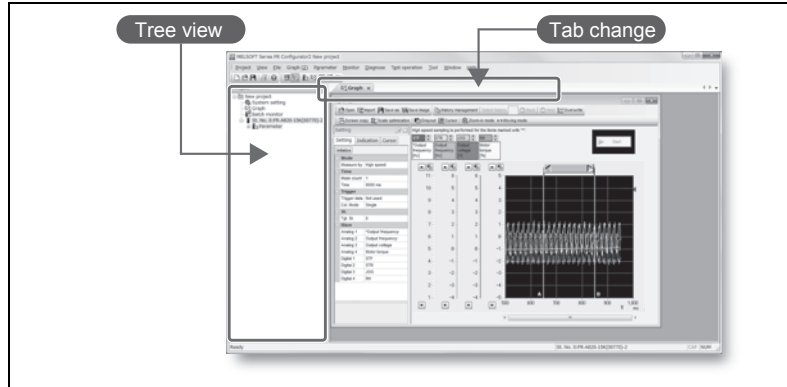

## ◆ Efficient startup settings

- System settings  
This sets the method used to connect the inverters and the computer. Automatic recognition of connected inverters can also be set. The station number, model, capacity, and plug-in options of the connected inverters can also be set manually.

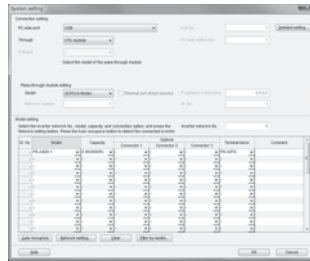

- Test operation  
Operating commands, frequency settings, and the operating mode can be set for the selected inverter

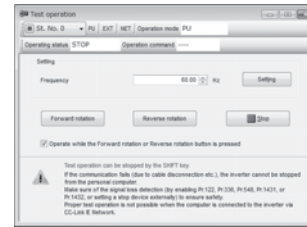

## ◆ Perform pre-operation adjustments and checks during operation with ease

- Parameter list  
Parameters for selected station numbers can be displayed and changed. I/O signals can be assigned using settings by function.

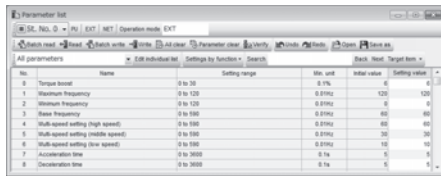

- Batch monitor function  
Multiple inverter monitor items can be monitored simultaneously. With a terminal monitor, the ON/OFF status can be monitored.

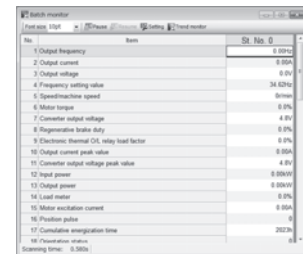

## ◆ Easy-to-follow platform facilitates easy maintenance

- Graph function  
Inverter data can be sampled and displayed in a graphical format. Trace data can also be read and displayed in a graph.

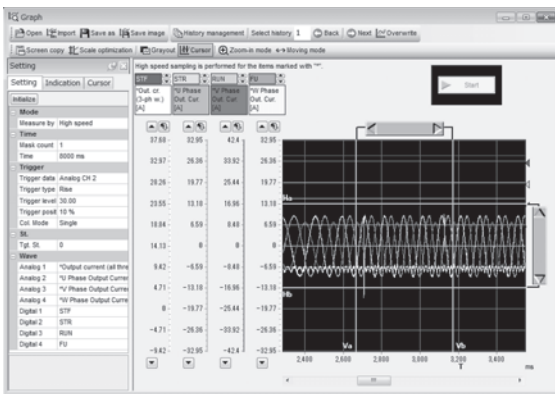

- Life diagnosis  
Life information read from the inverter is displayed. An alert icon is shown in the parts life alarm field for the parts recommended for replacement. The diagnosis result output function is available to output the data of diagnosis results to a file.

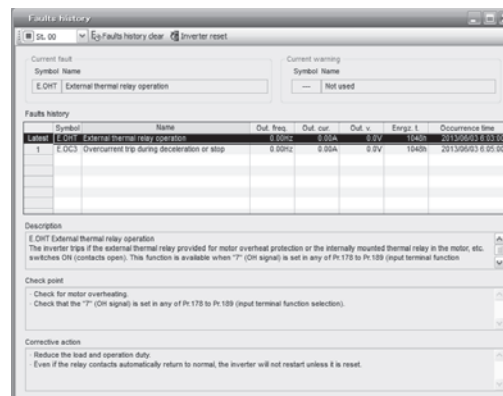

# Parameter list

## ● Parameter list (by parameter number)

For simple variable-speed operation of the inverter, the initial values of the parameters may be used as they are. Set the necessary parameters to meet the load and operational specifications. Parameter setting, change, and check can be made on the operation panel.



- The changing of the parameter settings may be restricted in some operating statuses. Use **Pr.77 Parameter write selection** to change the setting.

Function	Pr.	Pr. group	Name	Setting range	Minimum setting increment	Initial value	Customer setting
Basic function	0	G000	Torque boost	0 to 30%	0.1%	6%*1	
						4%*1	
						3%*1	
						2%*1	
	1	H400	Maximum frequency	0 to 120 Hz	0.01 Hz	120 Hz	
	2	H401	Minimum frequency	0 to 120 Hz	0.01 Hz	0 Hz	
	3	G001	Base frequency	10 to 400 Hz	0.01 Hz	50 Hz	
	4	D301	Multi-speed setting (high speed)	0 to 400 Hz	0.01 Hz	50 Hz	
	5	D302	Multi-speed setting (middle speed)	0 to 400 Hz	0.01 Hz	30 Hz	
	6	D303	Multi-speed setting (low speed)	0 to 400 Hz	0.01 Hz	10 Hz	
7	F010	Acceleration time	0 to 3600 s	0.1 s	5 s*2		
					10 s*2		
					15 s*2		
8	F011	Deceleration time	0 to 3600 s	0.1 s	5 s*2		
					10 s*2		
					15 s*2		
9	H000	Electronic thermal O/L relay	0 to 500 A	0.01 A	Inverter rated current		
DC injection brake	10	G100	DC injection brake operation frequency	0 to 120 Hz	0.01 Hz	3 Hz	
	11	G101	DC injection brake operation time	0 to 10 s	0.1 s	0.5 s	
	12	G110	DC injection brake operation voltage	0 to 30%	0.1%	4%*3	
2%*4							
—	13	F102	Starting frequency	0 to 60 Hz	0.01 Hz	0.5 Hz	
JOG operation	15	D200	Jog frequency	0 to 400 Hz	0.01 Hz	5 Hz	
	16	F002	Jog acceleration/deceleration time	0 to 3600 s	0.1 s	0.5 s	
—	17	T720	MRS input selection	0, 2, 4	1	0	
—	18	H402	High speed maximum frequency	120 to 400 Hz	0.01 Hz	120 Hz	
—	19	G002	Base frequency voltage	0 to 1000 V, 8888, 9999	0.1 V	8888	
Acceleration/ deceleration times	20	F000	Acceleration/deceleration reference frequency	1 to 400 Hz	0.01 Hz	50 Hz	
Stall prevention	22	H500	Stall prevention operation level	0 to 200%	0.1%	150%	
	23	H610	Stall prevention operation level compensation factor at double speed	0 to 200%, 9999	0.1%	9999	
Multi-speed setting	24 to 27	D304 to D307	Multi-speed setting (speed 4 to speed 7)	0 to 400 Hz, 9999	0.01 Hz	9999	
—	29	F100	Acceleration/deceleration pattern selection	0, 2	1	0	
—	30	E300	Regenerative function selection	0, 2	1	0	
Frequency jump	31	H420	Frequency jump 1A	0 to 400 Hz, 9999	0.01 Hz	9999	
	32	H421	Frequency jump 1B	0 to 400 Hz, 9999	0.01 Hz	9999	
	33	H422	Frequency jump 2A	0 to 400 Hz, 9999	0.01 Hz	9999	
	34	H423	Frequency jump 2B	0 to 400 Hz, 9999	0.01 Hz	9999	
	35	H424	Frequency jump 3A	0 to 400 Hz, 9999	0.01 Hz	9999	
	36	H425	Frequency jump 3B	0 to 400 Hz, 9999	0.01 Hz	9999	
—	40	E202	RUN key rotation direction selection	0, 1	1	0	
Frequency detection	41	M441	Up-to-frequency sensitivity	0 to 100%	0.1%	10%	
	42	M442	Output frequency detection	0 to 400 Hz	0.01 Hz	6 Hz	
	43	M443	Output frequency detection for reverse rotation	0 to 400 Hz, 9999	0.01 Hz	9999	

Function	Pr.	Pr. group	Name	Setting range	Minimum setting increment	Initial value	Customer setting
Second function	44	F020	Second acceleration/deceleration time	0 to 3600 s	0.1 s	5 s*2	
						10 s*2	
						15 s*2	
Automatic restart	45	F021	Second deceleration time	0 to 3600 s, 9999	0.1 s	9999	
	57	A702	Restart coasting time	0, 0.1 to 5 s, 9999	0.1 s	9999	
—	58	A703	Restart cushion time	0 to 60 s	0.1 s	1 s	
—	59	F101	Remote function selection	0 to 3	1	0	
—	60	G030	Energy saving control selection	0, 9	1	0	
—	65	H300	Retry selection	0 to 5	1	0	
—	66	H611	Stall prevention operation reduction starting frequency	0 to 400 Hz	0.01 Hz	50 Hz	
Retry	67	H301	Number of retries at fault occurrence	0 to 10, 101 to 110	1	0	
	68	H302	Retry waiting time	0.1 to 600 s	0.1 s	1 s	
	69	H303	Retry count display erase	0	1	0	
—	71	C100	Applied motor	0 to 2	1	0	
—	72	E600	PWM frequency selection	2 to 12	1	2	
—	73	T000	Analog input selection	0, 1, 10, 11	1	1	
—	74	T002	Input filter time constant	0 to 8	1	1	
—	75	—	Reset selection/disconnected PU detection/PU stop selection	0 to 3, 14 to 17	1	14	
		E100	Reset selection	0, 1		0	
		E101	Disconnected PU detection			1	
		E102	PU stop selection				
—	77	E400	Parameter write selection	0 to 2	1	2	
—	78	D020	Reverse rotation prevention selection	0 to 2	1	0	
—	79	D000	Operation mode selection	0 to 4	1	0	
Motor constant	80	C101	Motor capacity	0.2 to 15 kW, 9999	0.01 kW	9999	
	82	C125	Motor excitation current	0 to 500 A, 9999	0.01 A	9999	
	90	C120	Motor constant (R1)	0 to 50 Ω, 9999	0.001 Ω	9999	
	96	C110	Auto tuning setting/status	0, 1	1	0	
Adjustable 3 points V/F	100	G040	V/F1 (first frequency)	0 to 400 Hz, 9999	0.01 Hz	9999	
	101	G041	V/F1 (first frequency voltage)	0 to 1000 V	0.1 V	0 V	
	102	G042	V/F2 (second frequency)	0 to 400 Hz, 9999	0.01 Hz	9999	
	103	G043	V/F2 (second frequency voltage)	0 to 1000 V	0.1 V	0 V	
	104	G044	V/F3 (third frequency)	0 to 400 Hz, 9999	0.01 Hz	9999	
	105	G045	V/F3 (third frequency voltage)	0 to 1000 V	0.1 V	0 V	
PU connector communication	117	N020	PU communication station number	0 to 31(0 to 247)	1	0	
	118	N021	PU communication speed	48, 96, 192, 384, 576, 768, 1152	1	192	
	119	—	PU communication stop bit length / data length	0, 1, 10, 11	1	1	
		N022	PU communication data length	0, 1		0	
		N023	PU communication stop bit length	0, 1		1	
	120	N024	PU communication parity check	0 to 2	1	2	
	121	N025	PU communication retry count	0 to 10, 9999	1	1	
	122	N026	PU communication check time interval	0, 0.1 to 999.8 s, 9999	0.1 s	0	
	123	N027	PU communication waiting time setting	0 to 150 ms, 9999	1 ms	9999	
124	N028	PU communication CR/LF selection	0 to 2	1	1		
—	125	T022	Terminal 2 frequency setting gain frequency	0 to 400 Hz	0.01 Hz	50 Hz	
—	126	T042	Terminal 4 frequency setting gain frequency	0 to 400 Hz	0.01 Hz	50 Hz	
PID operation	127	A612	PID control automatic switchover frequency	0 to 400 Hz, 9999	0.01 Hz	9999	
	128	A610	PID action selection	0, 20, 21	1	0	
	129	A613	PID proportional band	0.1 to 1000%, 9999	0.1%	100%	
	130	A614	PID integral time	0.1 to 3600 s, 9999	0.1 s	1 s	
	131	A601	PID upper limit	0 to 100%, 9999	0.1%	9999	
	132	A602	PID lower limit	0 to 100%, 9999	0.1%	9999	
	133	A611	PID action set point	0 to 100%, 9999	0.01%	9999	
134	A615	PID differential time	0.01 to 10 s, 9999	0.01 s	9999		
PU	145	E103	PU display language selection	0 to 7	1	1	
Current detection	150	M460	Output current detection level	0 to 200%	0.1%	150%	
	151	M461	Output current detection signal delay time	0 to 10 s	0.1 s	0 s	
—	156	H501	Stall prevention operation selection	0 to 31, 100, 101	1	0	
—	157	M430	OL signal output timer	0 to 25 s, 9999	0.1 s	0 s	

Function	Pr.	Pr. group	Name	Setting range	Minimum setting increment	Initial value	Customer setting	
—	161	E200	Frequency setting / key lock operation selection	0, 1, 10, 11	1	0		
Automatic restart	165	A710	Stall prevention operation level for restart	0 to 200%	0.1%	150%		
Current detection	167	M464	Output current detection operation selection	0, 1	1	0		
—	168	E000 E080	Parameter for manufacturer setting. Do not set.					
—	169	E001 E081						
Cumulative monitor value clear	170	M020	Watt-hour meter clear	0, 10, 9999	1	9999		
	171	M030	Operation hour meter clear	0, 9999	1	9999		
Input terminal function assignment	178	T700	STF terminal function selection	0 to 5, 7, 8, 10, 14, 24, 25, 37, 60, 62, 9999	1	60		
	179	T701	STR terminal function selection	0 to 5, 7, 8, 10, 14, 24, 25, 37, 61, 62, 9999	1	61		
	180	T702	RL terminal function selection	0 to 5, 7, 8, 10, 14, 24, 25, 37, 62, 9999	1	0		
	181	T703	RM terminal function selection		1	1		
	182	T704	RH terminal function selection		1	2		
Output terminal function assignment	190	M400	NET Y0 terminal function selection	0, 1, 3, 4, 8, 11, 12, 14 to 16, 26, 46, 47, 64, 70, 91, 98, 99, 100, 101, 103, 104, 108, 111, 112, 114 to 116, 126, 146, 147, 164, 170, 191, 198, 199, 9999	1	0		
	191	M401	NET Y1 terminal function selection		1	1		
	192	M402	NET Y2 terminal function selection		1	3		
	193	M403	NET Y3 terminal function selection		1	9999		
	194	M404	NET Y4 terminal function selection		1	4		
195	M405	ABC terminal function selection	1	99				
Multi-speed setting	232 to 239	D308 to D315	Multi-speed setting (speed 8 to speed 15)	0 to 400 Hz, 9999	0.01 Hz	9999		
—	240	E601	Soft-PWM operation selection	0, 1, 10, 11	1	1		
Slip compensation	245	G203	Rated slip	0 to 50%, 9999	0.01%	9999		
	246	G204	Slip compensation time constant	0.01 to 10 s	0.01 s	0.5 s		
	247	G205	Constant-power range slip compensation selection	0, 9999	1	9999		
—	249	H101	Earth (ground) fault detection at start	0, 1	1	1		
—	250	G106	Stop selection	0 to 100 s, 1000 to 1100 s, 8888, 9999	0.1 s	9999		
—	251	H200	Output phase loss protection selection	0, 1	1	1		
Power failure stop	261	A730	Power failure stop	0 to 2	1	0		
	267	T001	Terminal 4 input selection	0 to 2	1	0		
—	269	E023	Parameter for manufacturer setting. Do not set.					
Password	296	E410	Password lock level	1 to 6, 101 to 106, 9999	1	9999		
	297	E411	Password lock/unlock	(0 to 5), 1000 to 9998, 9999	1	9999		
RS-485 communication	338	D010	Communication operation command source	0, 1	1	0		
	339	D011	Communication speed command source	0 to 2	1	0		
	340	D001	Communication startup mode selection	0, 1, 10	1	0		
	342	N001	Communication EEPROM write selection	0, 1	1	0		
	343	N080	Communication error count	—	1	0		
—	502	N013	Stop mode selection at communication error	0 to 2	1	0		
—	520	E415	Parameter for manufacturer setting. Do not set.					
Communication	549	N000	Protocol selection	0, 1	1	0		
	551	D013	PU mode operation command source selection	2, 4, 9999	1	9999		
—	573	A680	4 mA input check selection	1 to 3, 9999	1	9999		
PID control	575	A621	Output interruption detection time	0 to 3600 s, 9999	0.1 s	1 s		
	576	A622	Output interruption detection level	0 to 400 Hz	0.01 Hz	0 Hz		
	577	A623	Output interruption cancel level	900 to 1100%	0.1%	1000%		

Function	Pr.	Pr. group	Name	Setting range	Minimum setting increment	Initial value	Customer setting
Traverse	592	A300	Traverse function selection	0 to 2	1	0	
	593	A301	Maximum amplitude amount	0 to 25%	0.1%	10%	
	594	A302	Amplitude compensation amount during deceleration	0 to 50%	0.1%	10%	
	595	A303	Amplitude compensation amount during acceleration	0 to 50%	0.1%	10%	
	596	A304	Amplitude acceleration time	0.1 to 3600 s	0.1 s	5 s	
	597	A305	Amplitude deceleration time	0.1 to 3600 s	0.1 s	5 s	
—	598	H105	Undervoltage detection enable/disable selection	0, 1	1	1	
—	611	F003	Acceleration time at a restart	0 to 3600 s, 9999	0.1 s	9999	
—	631	H104	Inverter output fault detection enable/disable selection	0, 1	1	1	
Increased magnetic excitation deceleration	660	G130	Increased magnetic excitation deceleration operation selection	0, 1	1	0	
	661	G131	Magnetic excitation increase rate	0 to 40%, 9999	0.1%	9999	
	662	G132	Increased magnetic excitation current level	0 to 200%	0.1%	100%	
—	665	G125	Regeneration avoidance frequency gain	0 to 200%	0.1%	100%	
Monitoring	774	M101	Operation panel monitor selection 1	1 to 3, 5, 8, 10, 14, 20, 23 to 25, 52 to 55, 61, 62, 100	1	1	
	775	M102	Operation panel monitor selection 2		1	2	
	776	M103	Operation panel monitor selection 3		1	3	
—	778	T054	4 mA input check filter	0 to 10 s	0.01 s	0 s	
Protective function	872 <sup>*5</sup>	H201	Input phase loss protection selection	0, 1	1	1	
Regeneration avoidance	882	G120	Regeneration avoidance operation selection	0 to 2	1	0	
	883	G121	Regeneration avoidance operation level	300 to 800 V	0.1 V	400 VDC <sup>*6</sup> 780 VDC <sup>*7</sup>	
	885	G123	Regeneration avoidance compensation frequency limit value	0 to 10 Hz, 9999	0.01 Hz	6 Hz	
	886	G124	Regeneration avoidance voltage gain	0 to 200%	0.1%	100%	
Calibration parameter	C2 (902) <sup>*8</sup>	T200	Terminal 2 frequency setting bias frequency	0 to 400 Hz	0.01 Hz	0 Hz	
	C3 (902) <sup>*8</sup>	T201	Terminal 2 frequency setting bias	0 to 300%	0.1%	0%	
	125 (903) <sup>*8</sup>	T202	Terminal 2 frequency setting gain frequency	0 to 400 Hz	0.01 Hz	50 Hz	
	C4 (903) <sup>*8</sup>	T203	Terminal 2 frequency setting gain	0 to 300%	0.1%	100%	
	C5 (904) <sup>*8</sup>	T400	Terminal 4 frequency setting bias frequency	0 to 400 Hz	0.01 Hz	0 Hz	
	C6 (904) <sup>*8</sup>	T401	Terminal 4 frequency setting bias	0 to 300%	0.1%	20%	
	126 (905) <sup>*8</sup>	T402	Terminal 4 frequency setting gain frequency	0 to 400 Hz	0.01 Hz	50 Hz	
	C7 (905) <sup>*8</sup>	T403	Terminal 4 frequency setting gain	0 to 300%	0.1%	100%	
PU	990	E104	PU buzzer control	0, 1	1	1	
	991	E105	PU contrast adjustment	0 to 63	1	58	
Clear parameter	Pr.CL		Parameter clear	(0), 1	1	0	
	ALLC		All parameter clear	(0), 1	1	0	
	Er.CL		Fault history clear	(0), 1	1	0	
—	Pr.CH		Initial value change list	—	1	0	
—	Pr.MD		Group parameter setting	(0), 1, 2	1	0	

- \*1 Differs according to the capacity.  
6%: FR-CS84-022 or lower, FR-CS82S-042 or lower  
4%: FR-CS84-036 to FR-CS84-080, FR-CS82S-070, FR-CS82S-100  
3%: FR-CS84-120 and FR-CS84-160  
2%: FR-CS84-230 or higher
- \*2 Differs according to the capacity.  
5 s: FR-CS84-080 or lower  
10 s: FR-CS84-120 and FR-CS84-160, FR-CS82S-042 or lower  
15 s: FR-CS84-230 or higher
- \*3 The Initial value for the FR-CS84-160 or lower and the FR-CS82S-100 or lower.
- \*4 The initial value for the FR-CS84-230 or higher.
- \*5 Available only for the three-phase power input model.
- \*6 The value for the 200 V class.
- \*7 The value for the 400 V class.
- \*8 The parameter number in parentheses is the one used (displayed) on the LCD operation panel and the parameter unit.



## ● Changing the parameter setting value on the operation panel

**Example** Changing the setting of **Pr.1 Maximum frequency**.

### 1. Turning ON the power of the inverter

The operation panel will be in monitor mode.



### 2. Changing the operation mode

Press  to change the operation mode. Press  or  to choose the PU operation mode. The [PU] indicator turns ON.

### 3. Selecting the parameter setting mode

Press  to choose the parameter setting mode.





### 4. Selecting the parameter

Press  or  to show "P. 1" (Pr.1). Press  to read the present set value.

"1200" (initial value) will appear.

### 5. Changing the setting value

Press  or  to change the set value to "5000". Press  to enter the setting. "5000" and "P. 1" are displayed alternately.

- Press  or  to read another parameter.
- Press  twice to show the next parameter.
- Hold  for one second to return the display to the first screen in the monitor mode. (The monitor item initially set in the first screen is the frequency)

### NOTE

- If a parameter write condition is not satisfied, a parameter write error appears on the LCD display.

Error indication	Description
Er 1	Parameter write error
Er 2	Write error during operation
Er 3	Calibration error
Er 4	Mode designation error

- When **Pr.77 Parameter write selection** = "2 (initial value)", the parameter setting change is available only while the inverter is stopped and under the PU operation mode. To enable the parameter setting change while the inverter is running or under the operation mode other than PU operation mode, change the **Pr.77** setting.

# Protective Functions

## ● List of fault indications

If the displayed message does not correspond to any of the following or if you have any other problem, contact your sales representative.

### ◆ Error message

- Operation and setting faults are displayed on the operation panel and parameter unit. The inverter output is not shut off.

Operation panel indication		Name
HoLd	HOLD	Operation panel lock
LoCd	LOCD	Password locked
Er1 to Er4	Er1 to Er4	Parameter write error
Err.	Err.	Error

### ◆ Warning

- The inverter output is not shut off even when a warning is displayed. However, failure to take appropriate measures will lead to a fault.

Operation panel indication		Name
oLc	OLC	Stall prevention (overcurrent)
oLv	OLV	Stall prevention (overvoltage)
tH	TH	Electronic thermal O/L relay pre-alarm
pS	PS	PU stop
Uv	UV	Undervoltage
iH	IH	Inrush current limit resistor overheat

### ◆ Fault

- A protective function is activated, the inverter output is shut off, and the fault (ALM) signal is output.

Operation panel indication		Name
E.oC1	E.OC1	Overcurrent trip during acceleration
E.oC2	E.OC2	Overcurrent trip during constant speed
E.oC3	E.OC3	Overcurrent trip during deceleration or stop
E.ov1	E.OV1	Regenerative overvoltage trip during acceleration
E.ov2	E.OV2	Regenerative overvoltage trip during constant speed
E.ov3	E.OV3	Regenerative overvoltage trip during deceleration or stop
E.tHt	E.THT	Inverter overload trip (electronic thermal relay function)
E.tHm	E.THM	Motor overload trip (electronic thermal relay function)
E.Fin	E.FIN	Heatsink overheat
E.uVt	E.UVT	Undervoltage
E.iLf	E.ILF	Input phase loss
E.oLt	E.OLT	Stall prevention stop
E.gF	E.GF	Output side earth (ground) fault overcurrent
E.lF	E.LF	Output phase loss
E.oHt	E.OHT	External thermal relay operation
E.pE	E.PE	Parameter storage device fault
E.pE2	E.PE2	
E.pUE	E.PUE	PU disconnection
E.rEt	E.RET	Retry count excess
E.cPU	E.CPU	CPU fault
E.ES	E.5	
E.Cdo	E.CDO	Abnormal output current detection
E.iOH	E.IOH	Inrush current limit circuit fault
E.lCi	E.LCI	4 mA input fault
E.E10	E.E10	Inverter output fault

If faults other than the above appear, contact your sales representative.

## ● Reset method for the protective functions

Reset the inverter by performing any of the following operations. Note that the accumulated heat value of the electronic thermal relay function and the number of retries are cleared (erased) by resetting the inverter. The inverter recovers about 1 second after the reset is released.

- Press  on the operation panel to reset the inverter. (This operation is valid only when a protective function for a fault is activated.)

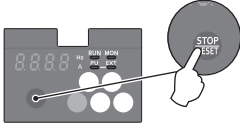

- Switch the power OFF once, then switch it ON again.

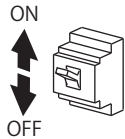

- Turn ON the Reset (RES) signal for 0.1 s or more. (If the RES signal is kept ON, "Err" appears (blinks) to indicate that the inverter is in a reset status.)

### NOTE

- OFF status of the start signal must be confirmed before resetting the inverter fault. Resetting an inverter fault with the start signal ON restarts the motor suddenly.

# Option and Peripheral Devices

## ● Option List

	Name	Model	Applications, Specifications, etc.	Applicable Inverter
Stand-alone Shared	Liquid crystal display operation panel	FR-LU08	Graphical operation panel with liquid crystal display *1	All capacities
	Parameter unit (8 languages)	FR-PU07	Interactive parameter unit with LCD display	All capacities
	Enclosure surface operation panel	FR-PA07	This operation panel enables inverter operation and monitoring of frequency, etc. from the enclosure surface	All capacities
	Parameter unit connection cable	FR-CB20[]	Cable for connection of operation panel or parameter unit [] indicates a cable length. (1m, 3m, 5m)	All capacities
	Operation panel connection connector	FR-ADP	A connector to connect the operation panel to the parameter unit connection cable.	All capacities
	DIN rail attachment	FR-UDA01, 02	Attachment for installation on DIN rail	According to capacities (excluding inverters FR-CS84-120 to 295).
	AC reactor	FR-HAL	For harmonic current reduction and inverter input power factor improvement	According to capacities
	EMC Directive compliant noise filter	SF FR-E5NF FR-S5NFSA	EMC Directive (EN61800-3 C3) compliant noise filter	According to capacities
	EMC compliant EMC filter installation attachment	FR-AAT02	For installation of the inverter to the EMC Directive compliant EMC filter (SF).	FR-CS84-230, 295
	Radio noise filter	FR-BIF(H)	For radio noise reduction (connect to the input side)	All capacities
	Line noise filter	FR-BSF01 FR-BLF	For line noise reduction	All capacities
	Brake unit Resistor unit Discharging resistor	FR-BU2 FR-BR GZG, GRZG type	For increasing the braking capability of the inverter (for high-inertia load or negative load) Brake unit, electrical-discharge resistor and resistor unit are used in combination	According to capacities
	Power regeneration common converter Stand-alone reactor dedicated for the FR-CV	FR-CV FR-CVL	Unit which can return motor-generated braking energy back to the power supply in common converter system	According to capacities
	High power factor converter	FR-HC2	The high power factor converter switches the converter section on/off to reshape an input current waveform into a sine wave, greatly suppressing harmonics. (Used in combination with the standard accessory.)	According to capacities
Surge voltage suppression filter	FR-ASF	Filter for suppressing surge voltage on motor	According to capacities (three-phase 400 V class only)	
	FR-BMF		According to capacities (FR-CS84-120 to 295 only)	
Others	Pilot generator	QVAH-10	For tracking operation. 70V/35VAC 500Hz (at 2500r/min)	All capacities
	Deviation sensor	YVGC-500W-NS	For continuous speed control operation (mechanical deviation detection) Output 90VAC/90°	
	Frequency setting potentiometer	WA2W 1kΩ	For frequency setting. Wire-wound 2W 1kΩ type B characteristic	
	Analog frequency meter (64mm × 60mm)	YM206NRI 1mA	Dedicated frequency meter (graduated to 130Hz). Moving-coil type DC ammeter	
	Calibration resistor	RV24YN 10kΩ	For frequency meter calibration. Carbon film type B characteristic	
	FR Configurator2 (Inverter setup software)	SW1DND-FRC2-E	Supports an inverter startup to maintenance.	

\*1 The battery (CR1216: a diameter of 12 mm, a height of 16 mm) is not bundled.

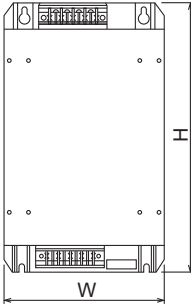
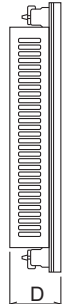
Name (Model)	Specifications, Structure, etc.																																																																			
DIN rail mounting attachments FR-UDA□	<ul style="list-style-type: none"> <li>Attachment to enable installation of FR-CS80 series on DIN rail.</li> <li>Selection table               <table border="1" data-bbox="391 309 933 452"> <thead> <tr> <th rowspan="2">Attachment Model</th> <th colspan="2">Inverter Capacity</th> </tr> <tr> <th>FR-CS84</th> <th>FR-CS82S</th> </tr> </thead> <tbody> <tr> <td>FR-UDA01</td> <td>012, 022</td> <td>025, 042</td> </tr> <tr> <td>FR-UDA02</td> <td>036, 050, 080</td> <td>070, 100</td> </tr> </tbody> </table> </li> <li>Approximate dimension               <div style="display: flex; justify-content: space-around;"> <div data-bbox="542 488 837 833"> <p><b>FR-UDA01</b></p> </div> <div data-bbox="917 488 1204 833"> <p><b>FR-UDA02</b></p> </div> </div> <p style="text-align: right;">(Unit: mm)</p> </li> </ul>	Attachment Model	Inverter Capacity		FR-CS84	FR-CS82S	FR-UDA01	012, 022	025, 042	FR-UDA02	036, 050, 080	070, 100																																																								
Attachment Model	Inverter Capacity																																																																			
	FR-CS84	FR-CS82S																																																																		
FR-UDA01	012, 022	025, 042																																																																		
FR-UDA02	036, 050, 080	070, 100																																																																		
EMC Directive compliant EMC filter SF FR-E5NF-H□K (400V class) FR-S5NFSA-□K (200V class)	<ul style="list-style-type: none"> <li>The EMC compliant EMC filter (EN61800-3 2nd Environment Category C3) is a filter compliant with the EU EMC Directive (EN61800-3 2nd Environment Category C3).</li> </ul> <table border="1" data-bbox="391 913 1181 1176"> <thead> <tr> <th rowspan="2">EMC filter Model</th> <th rowspan="2">Applicable inverter model</th> <th colspan="3">Outline dimension (Unit: mm)</th> <th rowspan="2">Mass (kg)</th> <th rowspan="2">Leakage current (mA) *2 (reference value)</th> <th rowspan="2">Loss (W)</th> </tr> <tr> <th>W</th> <th>H</th> <th>D</th> </tr> </thead> <tbody> <tr> <td>SF1306</td> <td>FR-CS82S-025, 042</td> <td>110</td> <td>200</td> <td>36.5</td> <td>0.7</td> <td>10</td> <td>7.3</td> </tr> <tr> <td>FR-E5NF-H3.7K</td> <td>FR-CS84-012 to 080</td> <td>140</td> <td>210</td> <td>46</td> <td>1.2</td> <td>44.5</td> <td>8</td> </tr> <tr> <td>FR-E5NF-H7.5K</td> <td>FR-CS84-120, 160</td> <td>220</td> <td>210</td> <td>47</td> <td>2</td> <td>68.4</td> <td>15</td> </tr> <tr> <td>FR-S5NFSA-1.5K</td> <td>FR-CS82S-070, 100</td> <td>110</td> <td>168</td> <td>47</td> <td>0.7</td> <td>9.5</td> <td>11</td> </tr> </tbody> </table> <div style="display: flex; justify-content: space-around; margin-top: 10px;">   </div> <table border="1" data-bbox="391 1232 1236 1406"> <thead> <tr> <th rowspan="2">EMC filter Model</th> <th rowspan="2">Applicable inverter model</th> <th rowspan="2">Intercompatibility attachment *1</th> <th colspan="4">Outline dimension (Unit: mm)</th> <th rowspan="2">Mass (kg)</th> <th rowspan="2">Leakage current (mA) *2 (reference value)</th> <th rowspan="2">Loss (W)</th> </tr> <tr> <th>W</th> <th>H</th> <th>D</th> <th>D1</th> </tr> </thead> <tbody> <tr> <td>SF1175</td> <td>FR-CS84-230, 295</td> <td>FR-AAT02</td> <td>253</td> <td>530</td> <td>60</td> <td>35</td> <td>4.7</td> <td>76</td> <td>56</td> </tr> </tbody> </table> <p style="margin-top: 10px;">*1 Depth is 12mm deeper when an intercompatibility attachment is installed.        *2 Leakage current for one phase of three-phase three-wire star-connection power supply.        Leakage current for all phases of three-phase three-wire delta-connection power supply is three times greater than the indicated value.</p> <p>(Note) This is a sample outline dimension drawing. The shape differs by the model.</p> <ul style="list-style-type: none"> <li>Prevention of leakage current          Take the following actions to prevent malfunction of peripheral devices or an electric shock caused by leakage current.           <ol style="list-style-type: none"> <li>1) Earth (ground) the EMC filter before connecting the power supply. When doing so, confirm that earthing (grounding) is securely performed through the earthing (grounding) part of the enclosure.</li> <li>2) Select an appropriate earth leakage circuit breaker or an earth leakage relay by considering leakage current of the EMC filter. Note that earth leakage circuit breaker may not be used in some cases such as when leakage current of the EMC filter is too large. In that case, use an earth leakage relay with high sensitivity. When both of earth leakage circuit breaker and earth leakage relay cannot be used, securely earth (ground) as explained in 1).</li> </ol> </li> </ul>	EMC filter Model	Applicable inverter model	Outline dimension (Unit: mm)			Mass (kg)	Leakage current (mA) *2 (reference value)	Loss (W)	W	H	D	SF1306	FR-CS82S-025, 042	110	200	36.5	0.7	10	7.3	FR-E5NF-H3.7K	FR-CS84-012 to 080	140	210	46	1.2	44.5	8	FR-E5NF-H7.5K	FR-CS84-120, 160	220	210	47	2	68.4	15	FR-S5NFSA-1.5K	FR-CS82S-070, 100	110	168	47	0.7	9.5	11	EMC filter Model	Applicable inverter model	Intercompatibility attachment *1	Outline dimension (Unit: mm)				Mass (kg)	Leakage current (mA) *2 (reference value)	Loss (W)	W	H	D	D1	SF1175	FR-CS84-230, 295	FR-AAT02	253	530	60	35	4.7	76	56
EMC filter Model	Applicable inverter model			Outline dimension (Unit: mm)						Mass (kg)	Leakage current (mA) *2 (reference value)	Loss (W)																																																								
		W	H	D																																																																
SF1306	FR-CS82S-025, 042	110	200	36.5	0.7	10	7.3																																																													
FR-E5NF-H3.7K	FR-CS84-012 to 080	140	210	46	1.2	44.5	8																																																													
FR-E5NF-H7.5K	FR-CS84-120, 160	220	210	47	2	68.4	15																																																													
FR-S5NFSA-1.5K	FR-CS82S-070, 100	110	168	47	0.7	9.5	11																																																													
EMC filter Model	Applicable inverter model	Intercompatibility attachment *1	Outline dimension (Unit: mm)				Mass (kg)	Leakage current (mA) *2 (reference value)	Loss (W)																																																											
			W	H	D	D1																																																														
SF1175	FR-CS84-230, 295	FR-AAT02	253	530	60	35	4.7	76	56																																																											

## ● Molded case circuit breaker, magnetic contactor, cable gauge

Voltage	Applicable inverter model	Motor output (kW)	Molded case circuit breaker (MCCB) or earth leakage circuit breaker (ELB) (NF, NV type) *1		Input side magnetic contactor *2		Recommended cable gauge (mm <sup>2</sup> ) *4		Reactor
			Power factor improving reactor connection		Power factor improving reactor connection		R/L1, S/L2, T/L3 *3	U, V, W	FR-HAL
			Without	With	Without	With			
Three-phase 400V	FR-CS84-012	0.4	5A	5A	S-T10	S-T10	2	2	H0.4K
	FR-CS84-022	0.75	5A	5A	S-T10	S-T10	2	2	H0.75K
	FR-CS84-036	1.5	10A	10A	S-T10	S-T10	2	2	H1.5K
	FR-CS84-050	2.2	15A	10A	S-T10	S-T10	2	2	H2.2K
	FR-CS84-080	3.7	20A	15A	S-T10	S-T10	2	2	H3.7K
	FR-CS84-120	5.5	30A	20A	S-T21	S-T12	3.5	2	H5.5K
	FR-CS84-160	7.5	30A	30A	S-T21	S-T21	3.5	3.5	H7.5K
	FR-CS84-230	11	50A	40A	S-T21	S-T21	8	8	H11K
	FR-CS84-295	15	60A	50A	S-T35	S-T21	8	8	H15K
Single-Phase 200V	FR-CS82S-025	0.4	10A	5A	S-T10	S-T10	2	2	0.75K*5
	FR-CS82S-042	0.75	15A	10A	S-T10	S-T10	2	2	1.5K*5
	FR-CS82S-070	1.5	30A	15A	S-T10	S-T10	2	2	2.2K*5
	FR-CS82S-100	2.2	40A	30A	S-T10	S-T10	3.5	2	3.7K*5

\*1 Select an MCCB according to the power supply capacity. Install one MCCB per inverter. For the use in the United States or Canada, provide the appropriate UL and cUL listed fuse that is suitable for branch circuit protection. (Refer to the FREQROL-CS80 Instructions and Cautions for Use of Inverters.)

\*2 The matrix shows the magnetic contactor selected according to the standards of Japan Electrical Manufacturers' Association (JEM standards) for AC-1 class. The electrical durability of magnetic contactor is 500,000 times. When the magnetic contactor is used for emergency stops during motor driving, the electrical durability is 25 times. If using an MC for emergency stop during motor driving, select an MC for the inverter input current according to the rated current against JEM 1038 standards for AC-3 class. When installing an MC at the inverter output line to switch to the commercial-power supply operation while running a general-purpose motor, select an MC for the rated motor current according to the rated current against JEM 1038 standards for AC-3 class.

\*3 When using a single-phase power input model, terminals are R/L1 and S/L2.

\*4 It is the gauge of a cable with the continuous maximum permissible temperature of 75°C (HIV cable (600 V grade heat-resistant PVC insulated wire), etc.). It assumes a surrounding air temperature of 50°C or lower and the wiring distance of 20 m or shorter.

\*5 The power factor may be slightly lower.

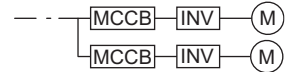

10

Option and Peripheral Devices

### NOTE

- When the inverter capacity is larger than the motor capacity, select an MCCB and a magnetic contactor according to the inverter model, and select cables and reactors according to the motor output.
- When the breaker on the inverter's input side trips, check for the wiring fault (short circuit), damage to internal parts of the inverter etc. The cause of the output shutoff must be identified and removed before turning ON the power of the breaker.

## ● Selecting the rated sensitivity current for the earth leakage circuit breaker

When using an earth leakage circuit breaker with the inverter circuit, select its rated sensitivity current as follows, independently of the PWM carrier frequency.

- Breaker designed for harmonic and surge suppression  
Rated sensitivity current  
 $I_{\Delta n} \geq 10 \times (I_{g1} + I_{gn} + I_{gi} + I_{g2} + I_{gm})$
- Standard breaker  
Rated sensitivity current  
 $I_{\Delta n} \geq 10 \times \{I_{g1} + I_{gn} + I_{gi} + 3 \times (I_{g2} + I_{gm})\}$   
I<sub>g1</sub>, I<sub>g2</sub>: Leakage currents in wire path during commercial power supply operation  
I<sub>gn</sub>: Leakage current of inverter input side noise filter  
I<sub>gm</sub>: Leakage current of motor during commercial power supply operation  
I<sub>gi</sub>: Leakage current of inverter unit

Example of leakage current of cable path per 1km during the commercial power supply operation when the CV cable is routed in metal conduit (200 V 60 Hz)

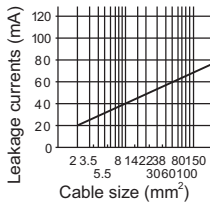

Example of leakage current per 1km during the commercial power supply operation when the CV cable is routed in metal conduit

(Three-phase three-wire delta connection 400 V 60 Hz)

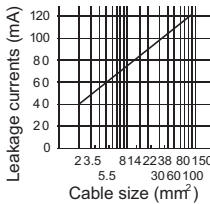

For "Δ" connection, the amount of leakage current is approx. 1/3 of the above value.

Leakage current example of three-phase induction motor during the commercial power supply operation (200 V 60 Hz)

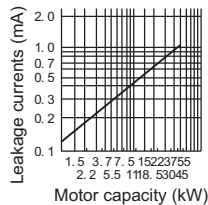

Leakage current example of three-phase induction motor during the commercial power supply operation

(Totally-enclosed fan-cooled type motor 400 V 60 Hz)

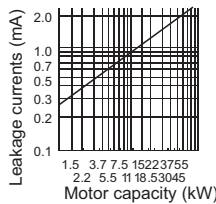

### Example

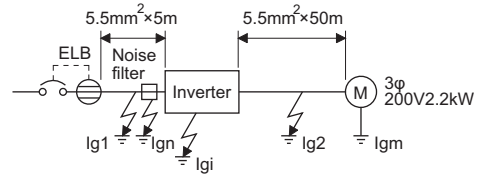

- (Note) 1. Install the earth leakage circuit breaker (ELB) on the input side of the inverter.  
2. In the Δ connection earthed-neutral system, the sensitivity current is blunt against a ground fault in the inverter output side. Earthing (grounding) must conform to the requirements of national and local safety regulations and electrical codes. (NEC section 250, IEC 61140 class 1 and other applicable standards)

### ● Selection example

	Breaker designed for harmonic and surge suppression	Standard breaker
Leakage current I <sub>g1</sub> (mA)	$33 \times \frac{5m}{1000m} = 0.17$	
Leakage current I <sub>gn</sub> (mA)	0 (without noise filter)	
Leakage current I <sub>gi</sub> (mA)	1	
Leakage current I <sub>g2</sub> (mA)	$33 \times \frac{50m}{1000m} = 1.65$	
Motor leakage current I <sub>gm</sub> (mA)	0.18	
Total leakage current (mA)	3.00	6.66
Rated sensitivity current (mA) (≥ I <sub>g</sub> × 10)	30	100

# Precautions for Operation/Selection

## ● Precautions for use of the inverter

### ◆ ⚠ Safety Precautions

- To use the product safely and correctly, make sure to read the "Instruction Manual" before use.
- This product has not been designed or manufactured for use with any equipment or system operated under life-threatening conditions.
- Please contact our sales representative when considering using this product for special applications such as passenger transportation, medical, aerospace, nuclear, power, or undersea relay equipment or system use.
- Although this product was manufactured under conditions of strict quality control, install safety devices to prevent serious accidents when it is used in facilities where breakdowns of the product or other failures are likely to cause a serious accident.
- Use only a three-phase induction motor as a load on this product.

### ◆ Operation

- When a magnetic contactor (MC) is installed on the input side, do not use the MC for frequent starting/stopping. Otherwise the inverter may be damaged.
- When a fault occurs in the inverter, the protective function is activated to stop the inverter output. However, the motor cannot be immediately stopped. For machinery and equipment that require an immediate stop, provide a mechanical stop/holding mechanism.
- It will take time for the capacitor to discharge after shutoff of the inverter power supply. When accessing the inverter for inspection, wait for at least 10 minutes after the power supply has been switched off, and check with a multimeter to make sure that there is no residual voltage.

### ◆ Wiring

- Applying the power to the inverter output terminals (U, V, W) causes a damage to the inverter. Before power-on, thoroughly check the wiring and sequence to prevent incorrect wiring, etc.
- The terminals P/+, N/- are provided for connection of a dedicated option. Connect only a dedicated option. Do not short the frequency setting power supply terminal 10 and common terminal 5 or the terminal PC and terminal SD.
- When disconnecting a wire from a control circuit terminal, push the open/close button all the way down with a flathead screwdriver, and pull out the wire. Pulling out the wire forcefully without pushing the open/close button all the way down may damage the terminal block.
- To prevent a malfunction due to noise, keep the signal cables 10cm or more away from the power cables. Also, separate the main circuit cables at the input side from the main circuit cables at the output side.
- After wiring, wire offcuts must not be left in the inverter. Wire offcuts can cause an alarm, failure or malfunction. Always keep the inverter clean. When drilling mounting holes in an enclosure, etc., take caution not to allow chips and other foreign matter to enter the inverter.
- Set the voltage/current input switch correctly. Incorrect setting may cause a fault, failure or malfunction.
- The output of the single-phase power input model is three-phase 200 V.

### ◆ Power supply

- When the inverter is connected under a large-capacity power transformer (500kVA or more transformer) or when a power capacitor is to be switched over, an excessive peak current may flow in the power input circuit, damaging the inverter. To prevent this, always install an optional AC reactor (FR-HAL).
- If a surge occurs in the power supply system, this surge energy may flow into the inverter, causing the inverter to display overvoltage protection (E.OV[]) and trip. To prevent this, always install an optional AC reactor (FR-HAL).

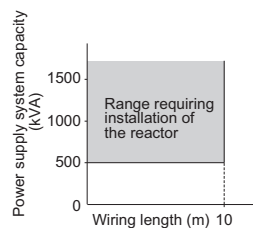

### ◆ Installation

- Install the inverter in a clean place with no floating oil mist, cotton fly, dust and dirt, etc. Alternatively, install the inverter inside the "sealed type" enclosure that prevents entry of suspended substances. For installation in the enclosure, decide the cooling method and the enclosure size to keep the surrounding air temperature of the inverter/the converter unit within the permissible range (for specifications, refer to **page 11**).
- Do not install the inverter on wood or other combustible material as parts of the inverter get hot.
- Attach the inverter vertically.

### ◆ Setting

- Depending on the parameter setting, high-speed operation (up to 400 Hz) is available. Incorrect setting will lead to a dangerous situation. Set the upper limit by using the upper frequency limit setting.
- Setting the DC injection brake operation voltage and operating time larger than their initial values causes motor overheating (electronic thermal O/L relay trip).

## ● Selection precautions

### ◆ Inverter capacity selection

- When operating a special motor or multiple motors in parallel by one inverter, select the inverter capacity so that 1.05 times of the total of the rated motor current becomes less than the rated output current of the inverter.

### ◆ Starting torque of the motor

- The start and acceleration characteristics of the motor driven by the inverter are restricted by the overload current rating of that inverter. Generally the torque characteristic is less than when the motor is started by a commercial power supply. If torque boost adjustment or General-purpose magnetic flux vector control cannot provide enough torque when a large starting torque is necessary, select the inverter of one rank higher capacity or increase the capacities of both the motor and inverter.

### ◆ Acceleration/deceleration time

- The motor acceleration/deceleration time is decided by the torque generated by the motor, load torque, and moment of inertia (J) of load.
- When the stall prevention function is activated during acceleration/deceleration, increase the acceleration/deceleration time as the actual time may become longer.
- To decrease the acceleration/deceleration time, increase the torque boost value (setting of a too large value may activate the stall prevention function at a start, longer the acceleration time), use the General-purpose magnetic flux vector control or increase the inverter and motor capacities. To shorten the deceleration time, the additional use of increased magnetic excitation deceleration, or options such as the optional brake unit (FR-BU2) or the power regeneration common converter (FR-CV) are required.

### ◆ Power transfer mechanisms (reduction gear, belt, chain, etc.)

- Caution is required for the low-speed continuous operation of the motor with an oil lubricated gear box, transmission, reduction gear, etc. in the power transfer mechanism. Such an operation may degrade the oil lubrication and cause seizing. On the other hand, the high-speed operation at more than 60 Hz may cause problems with the noise of the power transfer mechanism, life, or insufficient strength due to centrifugal force, etc. Fully take necessary precautions.

### ◆ Instructions for overload operation

- When performing operation of frequent start/stop of the inverter, rise/fall in the temperature of the transistor element of the inverter will repeat due to a repeated flow of large current, shortening the life from thermal fatigue. Since thermal fatigue is related to the amount of current, the life can be increased by reducing current at locked condition, starting current, etc. Decreasing current may increase the life. However, decreasing current will result in insufficient torque and the inverter may not start. Therefore, choose the inverter which has enough allowance for current.



# Precautions for Peripheral Device Selection

## ◆ Selection and installation of molded case circuit breaker

Install a molded case circuit breaker (MCCB) on the power receiving side to protect the wiring of the inverter input side. For MCCB selection, refer to **page 30** since it depends on the inverter power supply side power factor (which changes depending on the power supply voltage, output frequency and load). Especially for a completely electromagnetic MCCB, one of a slightly large capacity must be selected since its operation characteristic varies with harmonic currents. (Check the manual of the corresponding breaker.) As an earth leakage circuit breaker, use the Mitsubishi earth leakage circuit breaker designed for harmonics and surge suppression. (Refer to **page 31**)

When installing a molded case circuit breaker on the inverter output side, contact the manufacturer of each product for selection.

## ◆ Handling of the input side magnetic contactor

• For operations using external terminals (using terminal STF or STR), install the input-side magnetic contactor to prevent accidents due to automatic restart when the power is restored after power failures such as an instantaneous power failure, or for safety during maintenance works. Do not use this magnetic contactor for frequent starting/stopping of the inverter. (The switching life of the converter part is about 500,000 times.) In the operation by parameter unit, the automatic restart after power restoration is not performed and the magnetic contactor cannot be used to start the motor. The input-side magnetic contactor can stop the motor. However, the regenerative brake of the inverter does not operate, and the motor coasts to a stop.

## ◆ Handling of the output side magnetic contactor

Switch the magnetic contactor between the inverter and motor only when both the inverter and motor are at a stop. When the magnetic contactor is turned on while the inverter is operating, overcurrent protection of the inverter will activate. For instances in which an MC is provided to switch to a commercial power supply, first turn off the inverter and motor, then switch the MC.

## ◆ Installation of thermal relay

The inverter has an electronic thermal O/L relay to protect the motor from overheating. However, install an external thermal overcurrent relay (OCR) between the inverter and motors to operate several motors or a multi-pole motor with one inverter. In this case, set 0 A to the electronic thermal O/L relay setting of the inverter. For the external thermal overcurrent relay, determine the setting value in consideration of the current indicated on the motor's rating plate and the line-to-line leakage current. (Refer to **page 34**.)

For low-speed operation where the cooling capability of the motor reduces, it is recommended to use a thermal relay protector incorporated motor.

## ◆ Output side measuring instrument

When the inverter-to-motor wiring length is long, especially for the 400 V class, small-capacity models, the meters and CTs may generate heat due to line-to-line leakage current. Therefore, choose the equipment which has enough allowance for the current rating.

## ◆ Disuse of power factor improving capacitor (power factor correction capacitor)

Do not add a capacitor or surge suppressor to the inverter. This is because the power factor improving capacitor and surge suppressor on the inverter output side may be overheated or damaged by the harmonic components of the inverter output. Furthermore, the inverter already has inbuilt protection against excessive current flow. To improve the power factor, use a reactor.

## ◆ Electrical corrosion of the bearing

- When a motor is driven by the inverter, axial voltage is generated on the motor shaft, which may cause electrical corrosion of the bearing in rare cases depending on the wiring, load, operating conditions of the motor or specific inverter settings (high carrier frequency, use of a capacitive filter\*1).

Contact your sales representative to take appropriate countermeasures for the motor.

The following shows examples of countermeasures for the inverter.

- Decrease the carrier frequency.
- Remove the capacitive filter.
- Provide a common mode choke\*2 on the output side of the inverter. (This is effective regardless of the use of the capacitive filter.)

\*1 Mitsubishi Electric capacitive filter: FR-BIF, SF[], FR-E5NF-[], FR-S5NFS[A]

\*2 Recommended common mode choke: FT-3KM F series  
FINEMET® common mode choke cores manufactured by Hitachi Metals, Ltd.  
FINEMET is a registered trademark of Hitachi Metals, Ltd.

## ◆ Cable gauge and wiring distance

If the wiring distance is long between the inverter and motor, during the output of a low frequency in particular, use a large cable gauge for the main circuit cable to suppress the voltage drop to 2% or less. (The table on **page 30** indicates a selection example for the wiring length of 20 m.)

Especially for long-distance wiring or wiring with shielded cables, the inverter may be affected by a charging current caused by stray capacitances of the wiring, leading to an incorrect activation of the overcurrent protective function. Refer to the maximum wiring length shown in the following table. When multiple motors are connected, use the total wiring length shown in the table or shorter.

Cable type	Model FR-CS84-[]								
	012	022	036	050	080	120	160	230	295
Unshielded	50m	50m	50m	50m	50m	100m	100m	100m	100m
Shielded	25m	25m	50m	50m	50m	100m	100m	100m	100m

Cable type	Model FR-CS82S-[]			
	025	042	070	100
Unshielded	50m	50m	50m	50m
Shielded	25m	25m	50m	50m

When driving a 400 V class motor by the inverter, surge voltages attributable to the wiring constants may occur at the motor terminals, deteriorating the insulation of the motor. In this case, use a 400 V class inverter-driven insulation-enhanced motor.

When the wiring length is 50 m or more, set "8" (8 kHz) or less in **Pr.72 PWM frequency selection**.

Use the recommended connection cable when connecting the parameter unit.

For remote operation using analog signals, keep the distance between the remote speed setter and the inverter to 30 m or less. Also, to prevent induction from other devices, keep the wiring away from the power circuits (main circuit and relay sequential circuit). When setting the frequency using an external potentiometer rather than a parameter unit, use a shielded or twisted cable as shown in the figure below. Connect the shield cable to terminal 5, not to the earth (ground).

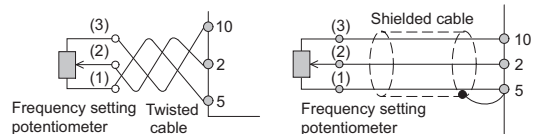

### ◆ Earth (ground)

When the inverter is run in the low acoustic noise mode, more leakage currents occur than in the non-low acoustic noise mode due to the high-speed switching operation. Be sure to earth (ground) the inverter and motor before use. In addition, always use the earth (ground) terminal of the inverter to earth (ground) the inverter. (Do not use the case or chassis)

### ◆ Electromagnetic interference (EMI)

For the low acoustic noise operation with high carrier frequency, electromagnetic noise tends to increase. Take precautions by referring to the following examples. Depending on the installation conditions, noise may also affect the inverter in the normal operation (initial status).

- Decrease the carrier frequency (Pr.72) setting to lower the EMI level.
- As measures against AM radio broadcasting noise, radio noise filter FR-BIF produces an effect.
- As measures against sensor malfunction, line noise filter FRBSF01, FR-BLF produces an effect.
- As measures against induction noise from the power cable of the inverter, an effect is produced by putting a distance of 30cm (at least 10cm) or more and using a twisted pair shielded cable as a signal cable. Do not earth (ground) shield but connect it to signal common cable.

#### EMI measure example

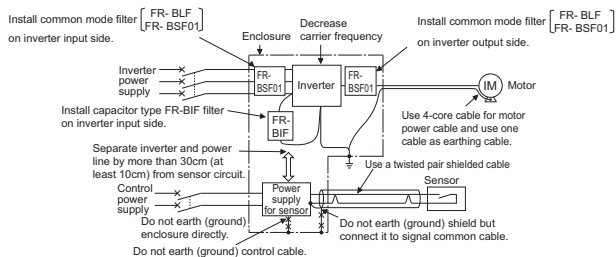

### Line-to-line leakage current

Type	Influence and countermeasure
Influence and countermeasure	<ul style="list-style-type: none"> <li>• This leakage current flows via a static capacitance between the inverter output cables.</li> <li>• The external thermal relay may be operated unnecessarily by the harmonics of the leakage current. When the wiring length is long (50m or more) for the 400V class model, the external thermal relay is likely to operate unnecessarily because the ratio of the leakage current to the rated motor current increases.</li> <li>• Precaution</li> <li>• Use <b>Pr.9 Electronic thermal O/L relay</b>.</li> <li>• If the carrier frequency setting is high, decrease the <b>Pr.72 PWM frequency selection</b> setting. However, the motor noise increases. Selecting <b>Pr.240 Soft-PWM operation selection</b> makes the sound inoffensive. To protect motor securely without being subject to the influence of the line-to-line leakage current, direct detection of the motor temperature using a temperature sensor is recommended.</li> </ul>
Transmission path	<p style="text-align: center;">Line-to-line leakage currents path</p>

### ◆ leakage current

Capacitances exist between the inverter I/O cables, other cables and earth and in the motor, through which a leakage current flows. Since its value depends on the static capacitances, carrier frequency, etc., low acoustic noise operation at the increased carrier frequency of the inverter will increase the leakage current. Therefore, take the following precaution. Select the earth leakage current breaker according to its rated sensitivity current, independently of the carrier frequency setting. (Refer to page 31)

#### To-earth (ground) leakage currents

Type	Influence and countermeasure
Influence and countermeasure	<ul style="list-style-type: none"> <li>• Leakage currents may flow not only into the inverter's own line but also into the other line through the earth (ground) cable, etc. These leakage currents may operate earth (ground) leakage circuit breakers and earth leakage relays unnecessarily.</li> <li>• Countermeasures</li> <li>• If the carrier frequency setting is high, decrease the <b>Pr.72 PWM frequency selection</b> setting. However, the motor noise increases. Selecting <b>Pr.240 Soft-PWM operation selection</b> makes the sound inoffensive.</li> <li>• By using earth leakage circuit breakers designed for harmonic and surge suppression in the inverter's own line and other line, operation can be performed with the carrier frequency kept high (with low noise).</li> </ul>
Transmission path	

# Warranty

Please confirm the following product warranty details before using this product.

## 1. Gratis Warranty Term and Gratis Warranty Range

If any faults or defects (hereinafter "Failure") found to be the responsibility of Mitsubishi occurs during use of the product within the gratis warranty term, the product shall be replaced at no cost via the sales representative.

### [Gratis Warranty Term]

The gratis warranty term of the product shall be for twelve (12) months after the date of purchase or delivery to a designated place.

Note that after manufacture and shipment from Mitsubishi, the maximum distribution period shall be six (6) months, and the longest gratis warranty term after manufacturing shall be eighteen (18) months.

### [Gratis Warranty Range]

- (1) The customer shall be responsible for the primary failure diagnosis unless otherwise specified.
- (2) The range shall be limited to normal use within the usage state, usage methods and usage environment, etc., which follow the conditions and precautions, etc., given in the instruction manual, user's manual and caution labels on the product.
- (3) Even within the gratis warranty term, the following cases are not guaranteed.
  - 1) Failure occurring from inappropriate storage or handling, carelessness or negligence by the user. Failure caused by the user's hardware or software design.
  - 2) Failure caused by unapproved modifications, etc., to the product by the user.
  - 3) When the Mitsubishi product is assembled into a user's device, Failure that could have been avoided if functions or structures, judged as necessary in the legal safety measures the user's device is subject to or as necessary by industry standards, had been provided.
  - 4) Failure that could have been avoided if consumable parts designated in the instruction manual had been correctly serviced or replaced.
  - 5) Replacing consumable parts such as capacitors and cooling fans.
  - 6) Failure caused by external irresistible forces such as fires or abnormal voltages, and Failure caused by force majeure such as earthquakes, lightning, wind and water damage.
  - 7) Failure caused by reasons unpredictable by scientific technology standards at time of shipment from Mitsubishi.
  - 8) Any other failure found not to be the responsibility of Mitsubishi or that admitted not to be so by the user.

## 2. Repair and Analysis

The repair and the failure analysis are not executed to the product.

## 3. Discontinuation of production

- (1) Discontinuation of production shall be notified with Mitsubishi Technical Bulletins, etc.
- (2) Product supply (including spare parts) is not available after production is discontinued.

## 4. Exclusion of loss in opportunity and secondary loss from warranty liability

Regardless of the gratis warranty term, Mitsubishi shall not be liable for compensation to damages caused by any cause found not to be the responsibility of Mitsubishi, loss in opportunity, lost profits incurred to the user by Failures of Mitsubishi products, special damages and secondary damages whether foreseeable or not, compensation for accidents, and compensation for damages to products other than Mitsubishi products, replacement by the user, maintenance of on-site equipment, start-up test run and other tasks.

## 5. Changes in product specifications

The specifications given in the catalogs, manuals or technical documents are subject to change without prior notice.

## 6. Product application

- (1) In using the Mitsubishi FR-CS80 series inverter, the usage conditions shall be that the application will not lead to a major accident even if any problem or fault should occur in the FR-CS80 series inverter, and that backup and fail-safe functions are systematically provided outside of the device for any problem or fault.
- (2) The Mitsubishi FR-CS80 series inverter has been designed and manufactured for applications in general industries, etc.

Thus, applications in which the public could be affected such as in nuclear power plants and other power plants operated by respective power companies, and applications in which a special quality assurance system is required, such as for Railway companies or Public service purposes shall be excluded from the FR-CS80 series inverter range of applications.

In addition, applications in which human life or property that could be greatly affected, such as in aircraft, medical applications, incineration and fuel devices, manned transportation equipment for recreation and amusement, and safety devices, shall also be excluded from the graphic operation terminal range of applications.

However, in certain cases, some applications may be possible, providing the user consults the local Mitsubishi representative outlining the special requirements of the project, and providing that all parties concerned agree to the special circumstances, solely at our discretion.

In some of three cases, however, Mitsubishi Electric Corporation may consider the possibility of an application, provided that the customer notifies Mitsubishi Electric Corporation of the intention, the application is clearly defined and any special quality is not required.

# Mitsubishi Electric's global FA network delivers reliable technologies and security around the world.

■ Production base   
 ● Development center   
 ● Global FA Center   
 ▲ Mechatronics showroom   
 ● Mitsubishi Electric sales office



## Available services



### Technical consultation (engineering)

Our Japanese and/or local staff offer technical advice, and can also propose the best products and systems for a customer's specific application needs.



### Showrooms

The latest automation technologies, including programmable controllers, HMIs, inverters, servo systems, and industrial automation machinery such as electrical-discharge machines, laser processing machines, CNCs, and industrial robots can be seen at Mitsubishi Electric showrooms.

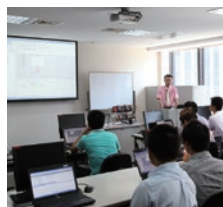

### Training

From basic operations to applied programming, our training schools offer regular courses that use actual machines. We also offer customized training programs and onsite training sessions.



### Technical support

Our FA centers and service shops work together to provide repairs, onsite engineering support, and spare parts.

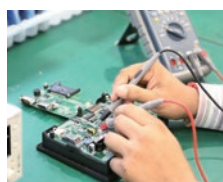

### Repairs

Handle repairs of our FA products.

Thailand FA Center  
 MITSUBISHI ELECTRIC FACTORY  
 AUTOMATION (THAILAND) CO.,LTD

Korea FA Center  
 MITSUBISHI ELECTRIC  
 AUTOMATION KOREA CO.,LTD.

MITSUBISHI ELECTRIC CORPORATION  
 Factory Automation Systems Group

Taichung FA Center  
 MITSUBISHI ELECTRIC  
 TAIWAN CO.,LTD

Taipei FA Center  
 SETSUJO ENTERPRISE CO.,LTD

Ho Chi Minh FA Center  
 MITSUBISHI ELECTRIC  
 VIETNAM COMPANY  
 LIMITED

Hanoi FA center  
 Mitsubishi Electric  
 Vietnam  
 Company Limited  
 Hanoi Branch

ASEAN FA Center  
 MITSUBISHI ELECTRIC ASIA PTE.LTD.

Beijing FA Center  
 MITSUBISHI ELECTRIC  
 AUTOMATION (CHINA)LTD.

Tianjin FA Center  
 MITSUBISHI ELECTRIC  
 AUTOMATION (CHINA)LTD.

Guangzhou FA Center  
 MITSUBISHI ELECTRIC  
 AUTOMATION (CHINA)LTD.

Service bases are established around the world to provide the same services as in Japan globally. Overseas bases are opening one after another to support our customers' business expansion.

Area	Our overseas	FA centers
EMEA	26	7
China	17	4
Asia	31	13
Americas	15	6
Others	1	0
Total	90	30

-As of July 2017

North America FA Center  
 MITSUBISHI ELECTRIC  
 AUTOMATION,INC.

Mexico Monterrey FA Center  
 Monterrey Office, Mitsubishi  
 Electric Automation, Inc.

Mexico FA Center  
 Querétaro Office, Mitsubishi  
 Electric Automation, Inc.

Mexico City FA Center  
 Mexico FA Center  
 Mexico Branch, Mitsubishi  
 Electric Automation, Inc.

Brazil FA Center  
 Mitsubishi Electric do Brasil  
 Comércio e Serviços Ltda.

Brazil Votorantim FA Center  
 MELCO CNC do Brasil  
 Comércio e Serviços S.A.

China

Shanghai FA Center  
 MITSUBISHI ELECTRIC  
 AUTOMATION (CHINA) LTD.

This solution solves customers' issues and concerns by enabling visualization and analysis that lead to improvements and increase availability at production sites.

Utilizing our FA and IT technologies and collaborating with e-Factory Alliance partners, we reduce the total cost across the entire supply chain and engineeringchain, and support the improvement initiatives and one-step-ahead manufacturing of our customers.



FA integrated solutions reduce total cost

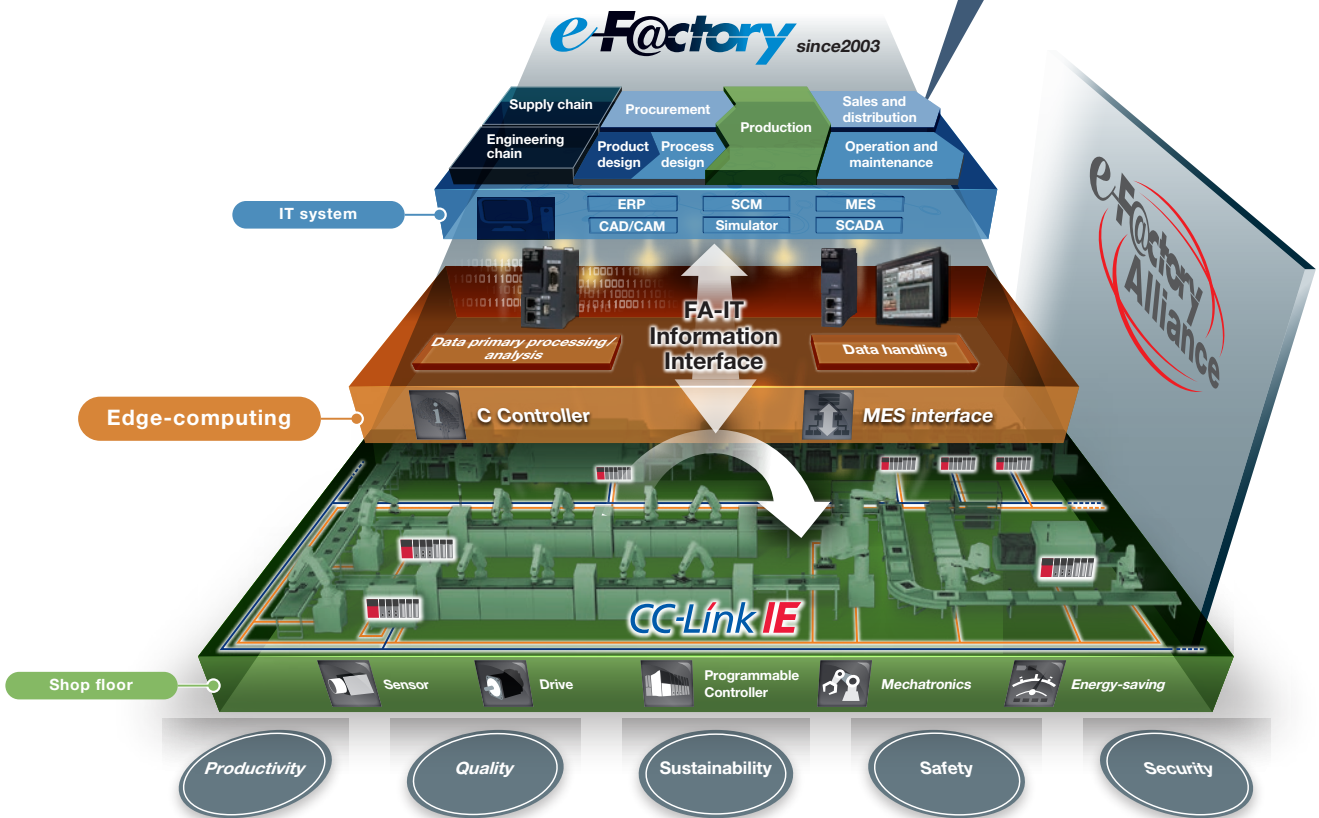
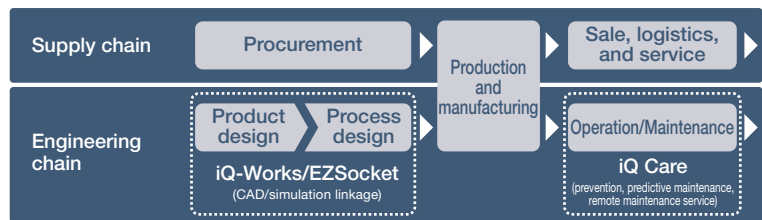

Overall production information is captured in addition to energy information, enabling the realization of efficient production and energy use (energy savings).

•Trademarks

MODBUS® is a registered trademark of Schneider Automation Incorporated. Other company and product names herein are the trademarks and registered trademarks of their respective owners.

# YOUR SOLUTION PARTNER

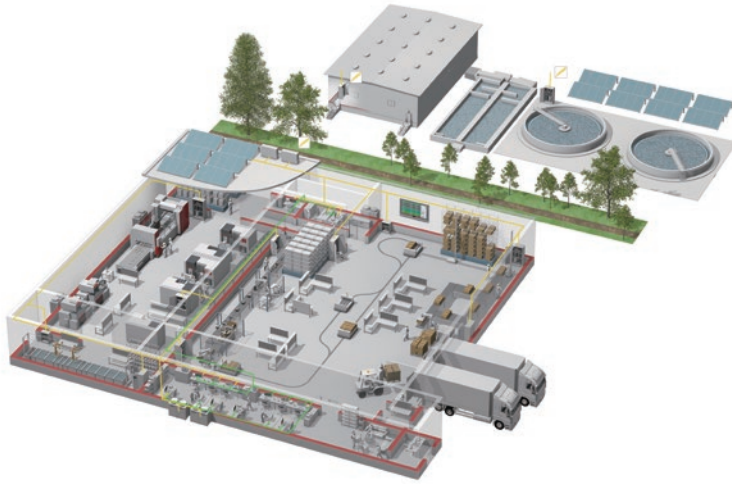

Mitsubishi Electric offers a wide range of automation equipment from PLCs and HMIs to CNC and EDM machines.

## A NAME TO TRUST

Since its beginnings in 1870, some 45 companies use the Mitsubishi name, covering a spectrum of finance, commerce and industry.

The Mitsubishi brand name is recognized around the world as a symbol of premium quality.

Mitsubishi Electric Corporation is active in space development, transportation, semi-conductors, energy systems, communications and information processing, audio visual equipment and home electronics, building and energy management and automation systems, and has 237 factories and laboratories worldwide in over 121 countries.

This is why you can rely on Mitsubishi Electric automation solution - because we know first hand about the need for reliable, efficient, easy-to-use automation and control in our own factories.

As one of the world's leading companies with a global turnover of over 4 trillion Yen (over \$40 billion), employing over 100,000 people, Mitsubishi Electric has the resource and the commitment to deliver the ultimate in service and support as well as the best products.



Low voltage: MCCB, MCB, ACB



Medium voltage: VCB, VCC



Power monitoring, energy management



Compact and Modular Controllers



Inverters, Servos and Motors



Visualisation: HMIs



Numerical Control (NC)



Robots: SCARA, Articulated arm



Processing machines: EDM, Lasers, IDS



Transformers, Air conditioning, Photovoltaic systems

\* Not all products are available in all countries.

Mitsubishi Electric Corporation Nagoya Works  
is a factory certified for ISO 14001  
(standards for environmental management  
systems).



# MITSUBISHI ELECTRIC CORPORATION

HEAD OFFICE: TOKYO BLDG., 2-7-3, MARUNOUCHI, CHIYODA-KU, TOKYO 100-8310, JAPAN